

FOCUS Ortho

The New Movement in Orthodontics



**Aria Metal
Brackets**
from as little as
50p each
Page 4

**NeoCrystal
Aesthetic
Brackets** only
£3.95
per bracket
Page 6

**Henry Schein
Stainless Steel
Archwires**
From only
£1.99
Page 19

**Hu-Friedy
Pliers**
**BUY 1 GET
1 HALF
PRICE**
Page 24

Retainer Brite
**NOW ONLY
£3.29**
Page 32

NEW Products

Introducing our brand new ranges of orthodontic products, including **Carrière Motion Clear™**, **Aria™ Brackets**, **NeoCrystal Brackets®**, **Nitanium Archwires** and much more.

Your guide
to fantastic
orthodontic
offers

Education

Carrière Philosophy is one of the many courses available to you from Henry Schein Education. visit hsdeducation.co.uk for more details

Welcome to your

Ortho

FOCUS

Your guide to everything orthodontics



You may already know us as the leading dental supplier in the UK, but now I'm excited to introduce our new dedicated service for orthodontics.

Henry Schein Dental Orthodontics is 100% committed to taking care of your practice so you can focus on what matters the most, your patients.

We do this in a number of ways. As well as providing a competitive and fast service on high-quality orthodontic materials, equipment, finance, training and servicing, we also have new specialist teams dedicated to supporting your business:

- Orthodontic product support, providing the latest support and guidance on products to help you meet/exceed your patients' requirements and run a more successful practice.
- CAD/CAM and digital imaging specialists to support your transition into digital dentistry.
- Practice management software specialists to help you manage your business effectively and increase your profitability.
- A team of specialists offering orthodontic educational courses to support training and development for the entire practice team.

With so many products to choose from, not to mention the new products coming out all the time, our account managers are on hand to provide you with full guidance and support, whatever your need.

We look forward to partnering with you for all your requirements.

Yours faithfully,

A handwritten signature in blue ink that reads "Alison Davies".

Alison Davies

Orthodontic Product Manager

Contents

| | | | |
|-----------------------------|-----|----------------------------|-------|
| Metal Brackets..... | 4-5 | Archwires..... | 17-21 |
| Aesthetic Brackets..... | 6-7 | Instruments..... | 22-27 |
| Carriere Motion..... | 8 | Elastomerics..... | 28-29 |
| Carriere Motion Clear..... | 9 | General Supplies..... | 30-32 |
| Self-ligating Brackets..... | 10 | Impression Materials..... | 33 |
| Buccal Tubes..... | 14 | Burs..... | 34 |
| Molar Bands..... | 15 | Adhesives and Cements..... | 34-38 |
| Intraoral..... | 16 | | |

“Henry Schein Dental is committed to taking care of your practice, so you can take care of your patients.”

Patrick Allen, Managing Director Henry Schein Dental (UK and Ireland)

Making things easier and simpler.

The day-to-day running of a practice can be stressful at times, which is why we try to help in whatever way we can, giving you complete peace of mind.

We supply the largest range of everyday items for your practice, which are all available on our website. Designed to make things simpler for you to place an order, our website is quick, easy to use and convenient - it can even help you with budgeting!



Ordering from henryschein.co.uk makes complete sense.

Vital statistics:

- Over 40,000 everyday products (leading brands like Ortho Organizers, 3M ESPE and GC)
- **Same-day despatch** if you order by 4pm from our brand new, state-of-the-art warehouse in Gillingham*
- Order 24/7, 365 days a week, with **free delivery**
- We still provide a personal service even though we have the largest field sales team in the country!

*Providing you have ordered from Henry Schein Dental before.

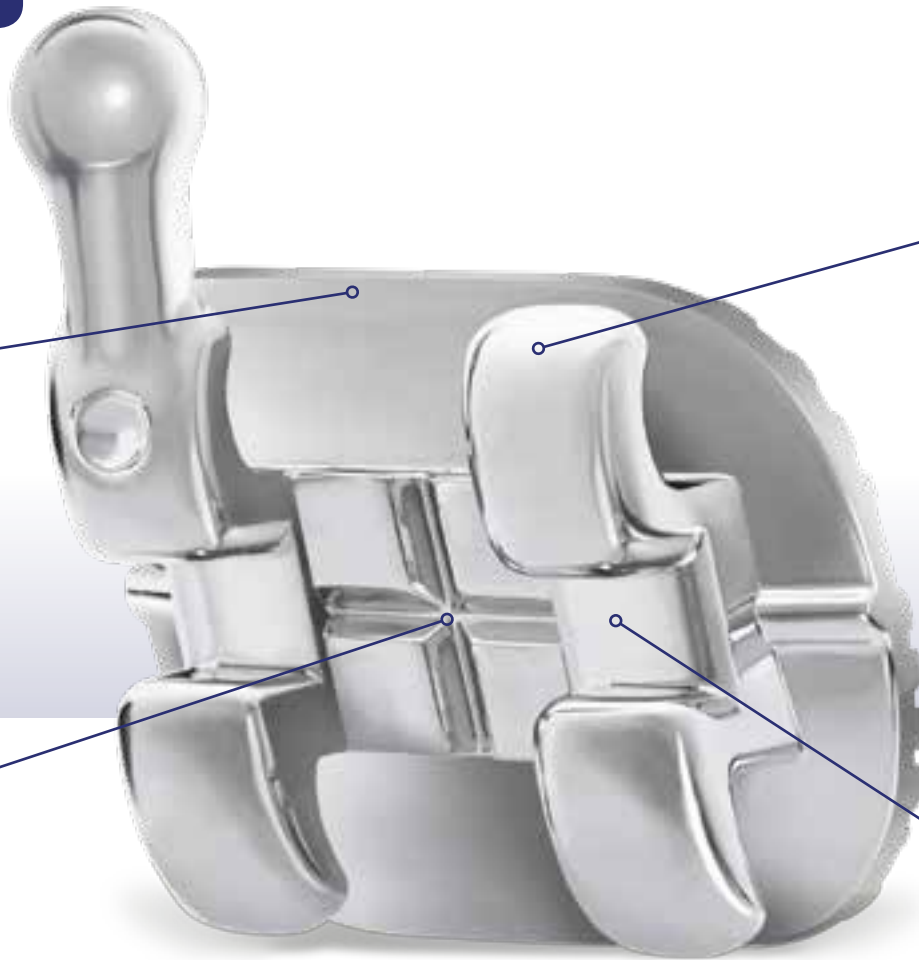
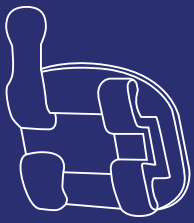

Rhomboid-shaped brackets and pads allow for maximum placement control

Smooth and rounded contours allow for maximum patient comfort

Patented Horizontal Scribe Line across the brackets and pads, mesial distal, creating additional visual cue, to enhance bracket placement

Rounded mesial and distal entrance minimises archwire notching thereby reducing "friction"

Aria™

Low-Profile Brackets

Optimising Precision, Comfort, and Control of the MIM-Manufactured Aria Bracket. Aria Low-Profile Brackets harmonise the enduring precepts of classic orthodontic design with state-of-the-art engineering. The result is a complete orthodontic appliance system that achieves the optimum clinical outcome in metal aesthetics, as well as the comfort that patients seek. The patented Horizontal Scribe Line (HSL) provides ideal visual cues for precise placement. The advanced Metal Injection Moulding (MIM) technology maintains the precision and control of the design, allowing for the outcomes that uncompromising practitioners require. A finely-tuned appliance design for predictable, efficient treatment, and discerning finishes.

**BRACKETS
FROM AS LITTLE AS
50P EACH**

Product codes 1165864 - 1165982
10 Brackets Per Pack

**KITS AVAILABLE
FROM £10.00**

Please call or see catalogue pages 4-5
for the full range of options available

Made in the USA

Quality Features Include:

Lowest possible profile reduces occlusal interferences

Smooth rounded surfaces ensure patient comfort

Contoured archwire slot edges mesial-Distal reduce friction

In/Outs Built-In, not machined for precision and consistency

Small footprint is less bulky than conventional twin brackets, minimising the look and feel

The Maestro Bracket offers multiple visual cues to enhance precise bracket placement

The geometries of the Maestro Bracket are specifically designed to provide signposts which assist you in positioning brackets in their ideal location.

Specific Bracket Geometries, such as in this lower lateral bracket, further guide the eye for placement accuracy

Rhomboid-Shaped Brackets and Pad align with tooth edges

Vertical Aspects Follow Long Axis of the Tooth Constant Occlusal-Gingival

Heights across the system foster placement repeatability

Horizontal Aspects Run Parallel to Occlusal Plane

Long Axis Scribe Line not only runs the entire length of the pad, but also the bracket for an accurate placement cue

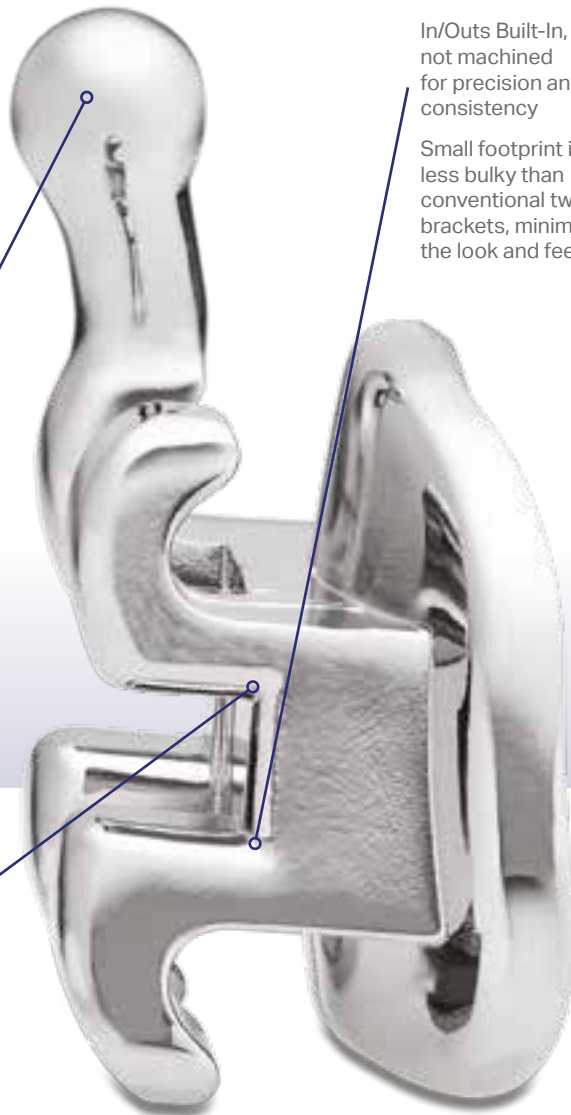

Maestro

Low-Profile Brackets System

The Maestro Low-Profile Bracket System harmonises the enduring precepts of classic orthodontic design with state-of-the-art engineering and production practices. The result is a complete orthodontic appliance system with corresponding buccal tubes - contemporary in form and function - that achieves the optimum in metal aesthetics and comfort that patients seek without sacrificing the precision and control that practitioners need. A finely-tuned appliance design for predictable, efficient treatment and discerning finishes.

BRACKETS FROM ONLY
£1.20 EACH
Product codes 1165255 - 1165831
10 Brackets Per Pack

KITS AVAILABLE FROM £24.00
Please call or see catalogue pages 9-11 for the full range of options available
Made in the USA

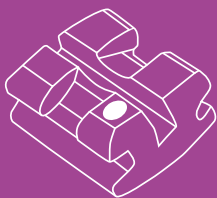

Unmatched Aesthetics

Pure monocrystalline material for a transparent, natural appearance

Stain resistant throughout treatment

Designed for Patient Comfort

Heat polished for a remarkably smooth surface

Low profile

Rounded corners

Single hook offers a less bulky feel than universal hooks

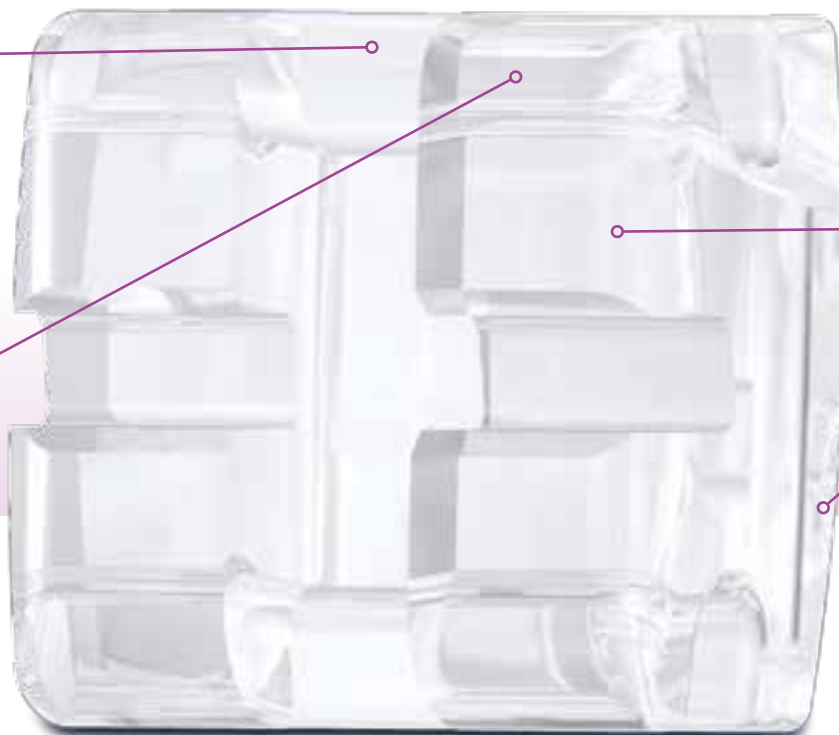

Enhanced Performance

Heat treated for increased strength

Reduced friction offers sliding mechanics comparable to metal brackets

Non-allergenic for sensitive patients

Anatomically contoured base for quick and easy bracket placement

Removable colour code ID mark to ensure accurate placement

NeoCrystal[®] Sapphire

Ceramic Bracket System

The "Crystal" clear advantage - Manufactured from pure monocrystalline material, the NeoCrystal Sapphire Ceramic Bracket is the clear aesthetic choice for your practice. NeoCrystal Brackets are developed from a single crystal sapphire, one of the hardest and clearest materials found in nature. Once machined out of the crystal, the brackets are then annealed for strength and heat-polished to perfect any microscopic flaws. The result is an unmatched aesthetic bracket that allows the natural tooth tone to show through, regardless of shade, for a virtually invisible appearance. Featuring our proprietary Crunch COAT™ Base and anatomically contoured base radii, the NeoCrystal Bracket provides the exceptional performance you demand.

NEOCRISTAL SAPHIRE ONLY

£3.95 PER BRACKET

Product codes 116552 - 1165671
5 Brackets Per Pack

KITS AVAILABLE FROM £47.40

Please call or see catalogue pages 18-20 for the full range of options available

Made in the USA

Clinical Performance

Accurate placement achieved with an easily removable colour coded ID mark

Strong bonding and predictable debonding with the Crunch COAT Base

Easy ligation with ample tie wing clearance

Superior Sliding Mechanics via a precision-cut archwire slot

Breakage Resistant

Non-allergenic for sensitive patients as brackets do not contain nickel, chromium, or other metals

Routine Protocol with no special instruments or adhesives required



Comfort

Designed with your patient's comfort in mind

Low profile

Smooth, polished surface

Rounded corners

Patient Satisfaction

Invisible Appearance – Crafted to the highest aesthetic standards

Translucent, natural appearance from 99.9% pure polycrystalline alumina

Stain-resistant throughout treatment

NeoLucent® Plus™

Ceramic Bracket System

The NeoLucent Plus Low-Profile Ceramic Bracket System delivers superb aesthetics by blending with the natural tooth tone for a virtually invisible appearance. With improved performance due to a Crunch COAT™ Base, more anatomically contoured base radii, and improved materials for a smoother finish and colour consistency; NeoLucent Plus Ceramic Brackets provide the definitive performance you demand. We are dedicated to providing world-class products and solutions to meet your every orthodontic need. As a full-service partner, we offer the tools to help expand your practice and diversify treatment options. So when your patients desire a cosmetic alternative, we have the right choice for you and them.

NEOLUCENT PLUS ONLY

£5.00 PER BRACKET

Product codes 1165176 - 1165235

5 Brackets Per Pack

KITS AVAILABLE FROM £100.00

Please call or see catalogue pages 23-24 for the full range of options available

Made in the USA

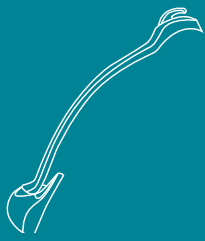

Education Courses 2017

Carrière Philosophy by Dr Luis Carrière

Course date: 17th May 2017

For more details visit hsdeducation.co.uk

Molar Pad Ball articulates in the socket

Metal Injection Moulded (MIM) for strength and proven performance

Stiff Arm runs posteriorly over the two upper premolars in a slight curve. Maintains exact space between pre molars during distalisation

Hooks on Pad for attachment of the Carrière Oral Elastics (1/4 inch, 6 ounces and/or 3/16 inch, 8 ounces of heavy elastic)

Sleek and Non-Invasive Design delivers greater comfort

Stainless Steel Material ensures malleability so that the appliance can be customised to every patient

Fixed Cuspid Pad allows the distal movement of the cuspid along the alveolar ridge



Loose but Controlled Forces

The ball and socket joint provides maximum freedom of movement, but also has built-in stops that allow the molars to move directly to their desired position, preventing any unwanted over rotation or tipping.

Carrière® Motion™

Class II Appliance

A huge move in the right direction for orthodontics.

To limit extractions and to turn difficult Class II patients into simpler Class I patients is a dream come true for you and your patients. With its sleek, aesthetic, and non-invasive design, the Motion Class II Correction Appliance provides greater comfort and shortens treatment time by up to four months. Delivering a natural, gentle, and uniform force for distal molar movement, with controlled rotation and tipping correction before brackets or other appliances are placed, the Motion Appliance solves complex problems almost effortlessly.

**Class III Appliance also available
- call for more details**

STANDARD KIT 1166133

WAS £279.99

NOW £199.99

**INDIVIDUAL PACKS
FROM £39.99**

Please call or see catalogue page 90 for the full range of options available

Made in the USA



The Carrière Motion Clear Class II Appliance offers the ultimate in aesthetic treatment

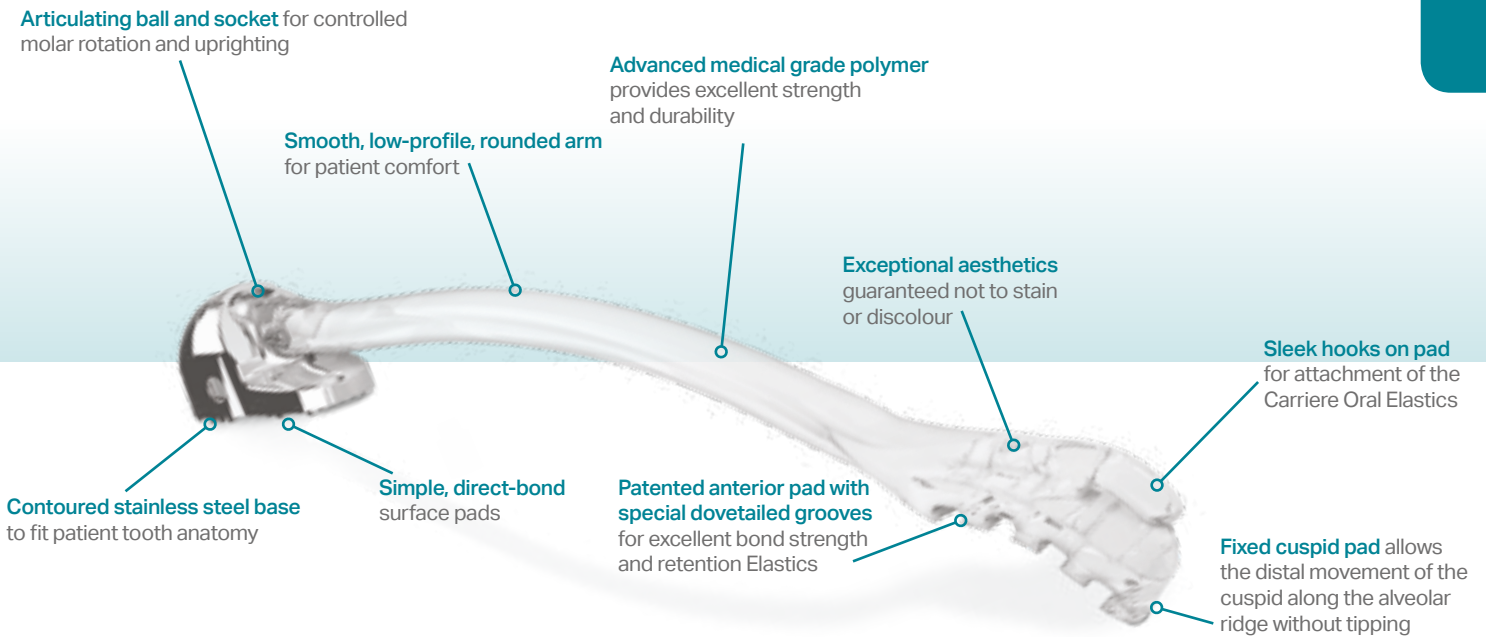

Carrière Motion Clear™ Class II Appliance

A huge move in the right direction for orthodontics.

Like its metal counterpart, the Carrière® Motion™ Class II appliance is based on the philosophy of achieving a stable Class I platform in the posterior segment at the onset of treatment in order to simplify treatment and reduce patient time in braces or aligners. This new treatment paradigm eliminates competing force vectors and patient compliance issues inherent in traditional Class II correction.

Whether it's the simplicity-of-use, the sleek patient-friendly design, or the remarkable speed and predictability of how it works, the Carrière Motion Clear™ Class II Appliance is truly extraordinary.

STANDARD KIT 1179108
WAS £2237.49
NOW £1789.99

INDIVIDUAL PACKS
FROM £50.39
 5 Brackets Per Pack

Please call for the full range of options available Made in the USA



Education Courses 2017

Carrière Philosophy

by **Dr Luis Carrière**

Course date: 17th May 2017

For more details visit hsdeducation.co.uk

Sure-Lok™ Clip for hygienic access and reliable functionality

More vertical and horizontal cues for faster, accurate placement

Smooth, secure and easy-to operate slides with audible and tactile cues

Occlusal opening, uppers and lowers to avoid gingival impingement



Deeper tie wings for easy, secure chain and ligature use

Fully Integrated Hooks eliminate the need for drop-in auxiliaries

Reduced slot depth for more precise tooth control

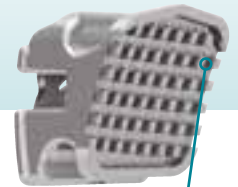
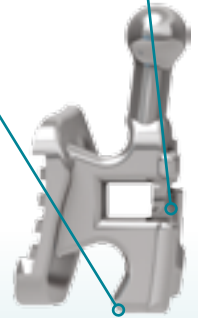

Adhesive Guard Rail™ (AGR) Technology directs adhesive mesialdistal for faster, easier clean-up

Introducing Brand New Carrière®

SLX™ Bracket System

The New Standard in Performance. The New Reality in Value.

It's the most exciting news in orthodontic appliance design in years. Introducing the completely re-engineered SLX Self-Ligating Appliance System. The SLX Bracket System resets the standards for excellence and performance in passive self-ligating brackets with numerous clinician-driven innovations for clinical effectiveness and efficiency. Discover the many innovative features of the SLX Bracket System — all designed to meet your ultimate goals — effective case management, optimal tooth positioning and meticulous finishes.

INTRO OFFER

£4.45 PER BRACKET

Product codes 1165435 - 1165547

10 Brackets Per Pack

KITS STARTING FROM £89.00 SAVING £31.00

Please call or see catalogue pages 14-15 for the full range of options available

Made in the USA

A New Class II Distalizer

by LUIS CARRIÈRE, DDS, MSD

The Carrière Distalizer* is a simple and efficient, fixed functional appliance for Class II treatment (Fig. 1). Developed with advanced computer technology, it represents an evolution of José Carrière's Modular Sectional Arch.¹

The Distalizer is most effective in treating Class II malocclusions without extractions. Brachyfacial patterns respond best to treatment; dolichofacial types are less responsive. The appliance can also be used in many Class I cases with mesially positioned maxillary molars or, with caution, in Class I cases with premaxillary hypoplasia. Growing patients are ideal, but adults can be treated as well. Mixed dentition Class II cases with fully erupted first molars are candidates for first-phase treatment.

Biomechanics

The Carrière Distalizer is designed to create a Class I molar and canine relationship that I call a Class I Platform of occlusion. This allows the case to be finished with any technique preferred by the orthodontist (Fig. 2). The biomechanical objectives of the appliance are as follows:

- Produce a distal rotational movement of the maxillary first molars around their palatal roots when necessary.
- Simultaneously produce a light, uniform force for distal molar movement.
- Independently move each posterior segment, from canine to molar, as a unit.
- Eliminate wire changes and thus the distorting collateral forces that appear with every wire activation in traditional methods.
- Minimise root resorption.

The clinical evidence of the achievement of these objectives will be the appearance of interincisal diastemas and wide spaces mesial to the canines.



Appliance Design

The Distalizer is made of injection-moulded, nickel-free, stainless steel. It is bonded to the canine and first molar as follows:

The canine pad, which allows distal movement of the canine along the alveolar ridge without tipping, carries a hook for the attachment of Class II elastics (Fig. 3). It is connected to an arm that runs posteriorly over the two upper premolars in a slight curve. The posterior end of the arm is a ball that articulates in a socket on the *molar pad* (Fig. 4).

This *ball* and *socket* were designed with three-dimensional virtual-reality models² to resemble the human hip joint, providing maximum freedom of movement in the appropriate direction. Raised surfaces on the ball articulate with depressions in the socket at a maximum orientation of -15° to the longitudinal axis of the arm, to limit undesirable movements and provide torque control over the canine and molar (Fig. 5).

This posterior portion of the Distalizer accomplishes three types of molar movement:

1. Uprighting of the crown, if it is mesially inclined (Fig. 6). Once the molar has been uprighted, the articulation of the ball with the socket prevents distal tipping.
2. Distal rotation around the palatal root. When the maxillary first molar is mesially rotated around the palatal root, the molar occlusion may appear to be Class I, while in reality it is Class II, with the canines in a cusp-to-cusp relationship (Fig. 7). When the molar has been derotated, the shoulder of the posterior base contacts the mesial arm to prevent over rotation.
3. Distal displacement without concurrent distal tipping of the crown (Fig. 8).



Dr Carrière is the inventor of both the internationally known Carrière Self-Ligating Bracket and the Carrière Motion™ Appliance. He is a world-renown lecturer on these products, in addition to many other topics.

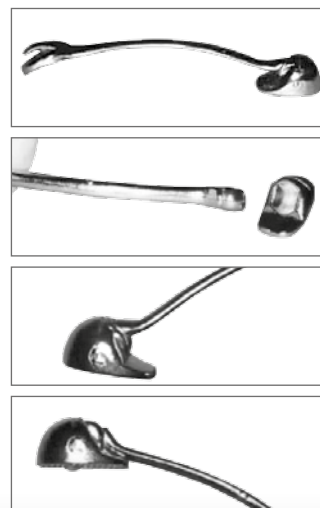

Fig. 1 Carrière Distalizer.

Appliance Placement

The Distalizer comes in three different sizes: 23mm, 25mm and 27mm. The appropriate size is determined by measuring from the midpoint of the maxillary first molar's buccal surface to the midpoint of the maxillary canine crown, using a caliper or a "Dentometer" (Fig. 9). In a case with an inaccessible high canine, and the maxillary second molars present, the measurement can be taken from the midpoint of the second molar crown to the midpoint of the first premolar. The appliance is then bonded to these teeth, rather than to the first molar and canine, so that the posterior teeth can be distalised to provide space for the blocked-out upper canine.

Teeth to be bonded are etched, then a light-cured adhesive is placed on the two bonding pads of the Distalizer. The molar attachment is positioned in the centre of the buccal surface with thumb pressure, then cured. There will be adequate time remaining to position the canine pad correctly before curing it.

Possible Sources of Anchorage

Anchorage must be carefully selected, depending on the patient's skeletal and neuromuscular pattern, to avoid protrusion of the lower incisors. It may include one or more of the following sources:

- 1. Passive Lingual Arch** - A passive .036" lingual wire, completely adapted to the mandibular dental anatomy, runs from molar to molar—the second molars if they have erupted (Fig. 10).
- 2. Hamula Lingual Arch** - This .045" round stainless steel lingual wire is attached with Hamula First Fit* molar bands, which come with mesial and distal occlusal stops. Two segments of .021" x .025" wire are soldered occlusally to the stops and then bonded to the occlusal surfaces of the premolars and molars. The edgewise wire rests on the occlusal surfaces without any interference (Fig. 11).
- 3. Full Mandibular Fixed Appliance** - In a non-extraction case with a severe curve of Spee or mild crowding in the mandibular arch, it is advisable to bond lower brackets and prepare anchorage to support the Class II elastic traction.
- 4. Lower Essix Appliance** - An Essix** appliance is another option for elastic attachment. The material used should be .040" Essix type A. For optimum stability of the elastics and mechanical retention,



Fig. 3 Carrière Distalizer with Class II elastic attached to hook on canine pad.

the appliance should be fabricated with small composite wedges bonded to the buccal surfaces of the lower molars and premolars. Hooks for elastic attachment are placed in the lower molar region.

- 5. Miniscrews** - These implants can be used for a short period at the beginning of orthodontic treatment. Because they are not osseointegrated, they can be easily inserted and removed. In the mandibular arch, for attachment of Class II elastics, they are best placed through the attached gingiva between the first and second molars. In the maxillary arch, miniscrews placed in the zygomatic buttress offer an alternative for elastic attachment in non-compliant patients.

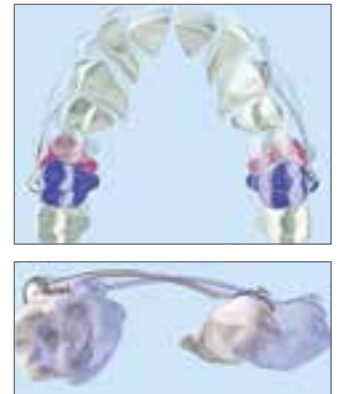

Fig. 2 Maxillary molars are distalised and rotated, providing platform for maxillary canines to occlude in Class I relationship.

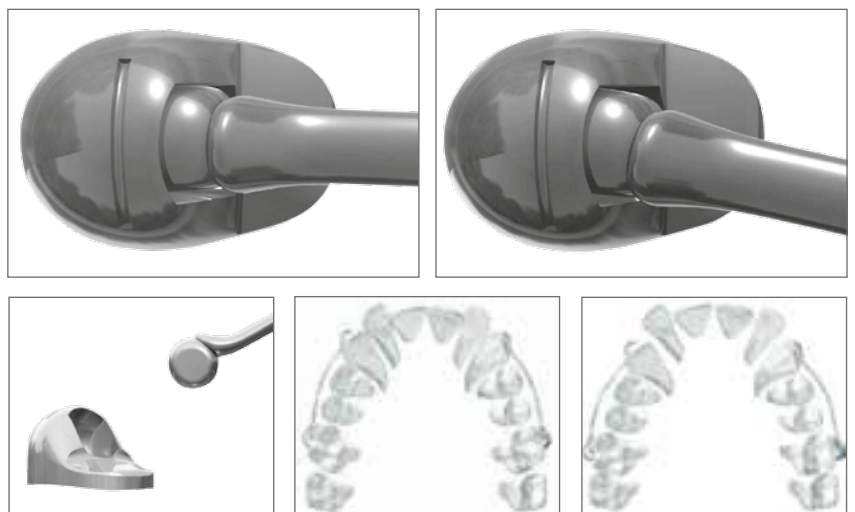

Fig. 4 Ball-and-socket joint articulates during molar derotation and distalisation to limit undesirable movements.

*ClassOne Orthodontics, Inc., 5064 50th St., Lubbock, TX 79414.

**Registered trademark of Raintree Essix, Inc., 4001 Division St., Metairie, LA 70002.



Fig. 5 Ball-and-socket joint provides molar torque control.



Fig. 7 With mesially rotated maxillary molars, canines cannot occlude in Class I relationship.

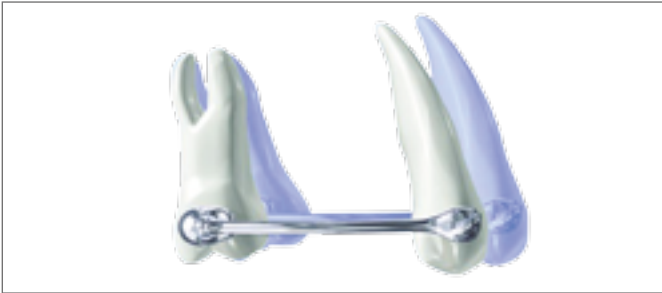

Fig. 6 Correction of mesial molar inclination.

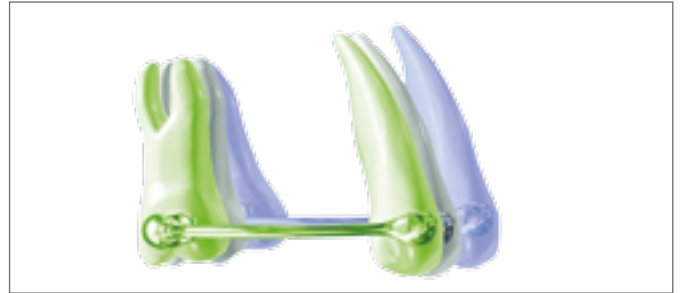

Fig. 8 Bodily distalisation of molar, combined with derotation.

Patient Instructions

Heavy, 6½oz, ¼" Class II elastics should be worn 24 hours a day, except during meals, in low-angle cases with good perioral muscular strength. Elastic wear can be limited to 14 hours a day, including sleeping hours, in high-angle cases with lighter perioral musculature. The elastics should not be worn while chewing because of the vertical force vector produced by these movements. A predominantly vertical vector may be expressed in a mild extrusion of the canines during distalisation, which can easily be compensated for in the following stages of treatment. Night-time wear provides a more horizontal vector of traction, but will prolong the distalisation period.

The patient should be instructed not to use the tongue to interfere with the Distalizer's horizontal arm, because this could result in a lingual inclination of the upper premolars. Another habit to avoid is placing the tip of the tongue in the spaces created between the upper lateral incisors and canines during distalisation. This will be indicated by a mild redness at the mesioingival border of the upper canines and may result in a widening of the spaces mesial to the canines in relation to the interincisal diastema.

Patient acceptance of the Distalizer has been gratifying, probably because the upper incisors are left free of appliances and the mandibular anterior region contains only an invisible lingual arch or Essix appliance.

Additionally, the Distalizer is relatively comfortable and is used in the first three to six months of treatment when compliance is best. The patient's morale is boosted by the immediate appearance of a diastema between the upper incisors showing the progress of distalisation. Avoidance of premolar extractions is a good bargain for a few months of cooperation with elastic wear.

Case Reports

The three cases were treated with the Carrière Distalizer until they reached the "Class I Platform". All three displayed wide interincisal diastemas after three or four months of distalisation. The panoramic X-rays demonstrate the preserved axial parallelism of the maxillary cuspids, premolars, and first molars after their distal displacement. Cephalometric tracings show the distalisation of the buccal segments and the response of the other dentofacial structures during this short treatment period.

REFERENCES

1. Carrière, J.: The Inverse Anchorage Technique in Fixed Orthodontic Treatment, Quintessence Publishing Co., Chicago, 1991.
2. Carrière, J. and Carrière, L: Softlanding treatment through inverse anchorage and virtual reality, J. Clin. Orthod. 29:479-486, 1995.



Fig. 9 Distalizer size determined by measuring from midpoint of maxillary first molar's buccal surface to midpoint of maxillary canine crown.



Fig. 10 Passive .036" lingual arch.



Fig. 11 Hamula Lingual Arch.

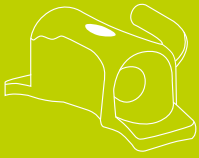

Quality Features Include:

Non-slip side grip areas for tweezers to hold and position bracket

Defined buccal indent for accurate stability and placement

Compound contoured base design for superior fit and bond strength

80-gauge mesh (micro-etched) bondable pad to maximise bond adhesion

Colour coded ID mark for easy identification

Smooth round surfaces and lowered mesiogingival hooks to ensure patient comfort

Large funnelled entrance with notch as guide for wire insertion



Maestro Buccal Tube product characteristics:

- Lowest possible profile to optimise patient comfort without hindering the precision and control needed for case completion
- Patient comfort is ensured with smooth rounded surfaces and lowered mesiogingival hooks
- Available as a direct bond or weld-able
- Metal Injection Moulded (MIM) stainless steel material for strength and proven performance

Maestro

Buccal Tubes

Classic orthodontic design with a smooth modern flair

The Maestro Buccal Tube completes the appliance system. It is a non-convertible, single-tube that harmonises classic orthodontic designs with the needs of today's practitioners and patients. This design provides the precise control needed throughout all phases of treatment for a predictable finish. The Maestro Buccal Tube's large funnelled entrance, side-grip areas and colour coding help simplify treatment by allowing for easier identification, placement, positioning and wire insertion. The ease of use associated with this product also reduces chair time which makes the Maestro Buccal Tube an extremely cost-effective choice for your practice.

**MAESTRO BUCCAL TUBES
FOR ONLY**

£1.79 PER TUBE

Product codes 1165686 - 1165797

10 Buccal Tubes Per Pack

Made in the USA



Tempra Molar Bands

When only the best will do.

- Superior tooth morphology
- Full tempered
- Memory and elasticity maintained after prefit and removal
- Proportional graduated half-sizing, numbered 29½ – 44
- Increased occlusal edge strength to prevent deformation
- Stiffer material to withstand additional pressure of extraoral and intraoral appliances
- Available with micro-etched Interiors for maximum retention

TEMPRA MOLAR BAND KITS ONLY
£1.99 PER BAND
 Kits consist of 50 bands
 For more details on Molar Band options please call today on 0800 023 2558

Tempra Band Kits Half Sizes 29½ - 44

All Band Kits can be ordered as Loose Bands or Pre-welded Assemblies. Also, Band Kits may be ordered either for the upper or lower molars, or the 1st or 2nd molars. Band Coding: legibly marked on mesial side: "U" indicates Upper; "L" indicates Lower; "S" indicates 2nd Molar; "R" indicates Right; "L" indicates Left.

Introductory Kit

| Band Size | 29½ | 30 | 30½ | 31 | 31½ | 32 | 32½ | 33 | 33½ | 34 | 34½ | 35 | 35½ | 36 | 36½ | 37 | 37½ | 38 | 38½ | 39 | 39½ | 40 | 40½ | 41 | 41½ | 42 | 42½ | 43 | 43½ | 44 | Total |
|-------------------------------|-----|----|-----|----|-----|----|-----|----|-----|----|-----|----|-----|----|-----|----|-----|----|-----|----|-----|----|-----|----|-----|----|-----|----|-----|----|-------|
| Full range quantity for right | 1 | 1 | 1 | 1 | 1 | 2 | 2 | 2 | 2 | 2 | 2 | 2 | 3 | 3 | 3 | 2 | 2 | 2 | 2 | 2 | 2 | 2 | 1 | 1 | 1 | 1 | 1 | 1 | 1 | 1 | 50 |
| Full range quantity for Left | 1 | 1 | 1 | 1 | 1 | 2 | 2 | 2 | 2 | 2 | 2 | 2 | 3 | 3 | 3 | 2 | 2 | 2 | 2 | 2 | 2 | 2 | 1 | 1 | 1 | 1 | 1 | 1 | 1 | 50 | |
| Mid range quantity for Left | | | | | | | | 4 | 4 | 4 | 4 | 5 | 5 | 4 | 4 | 4 | 4 | 4 | 4 | | | | | | | | | | | 50 | |
| Mid range quantity for Right | | | | | | | | 4 | 4 | 4 | 4 | 5 | 5 | 4 | 4 | 4 | 4 | 4 | 4 | | | | | | | | | | | 50 | |

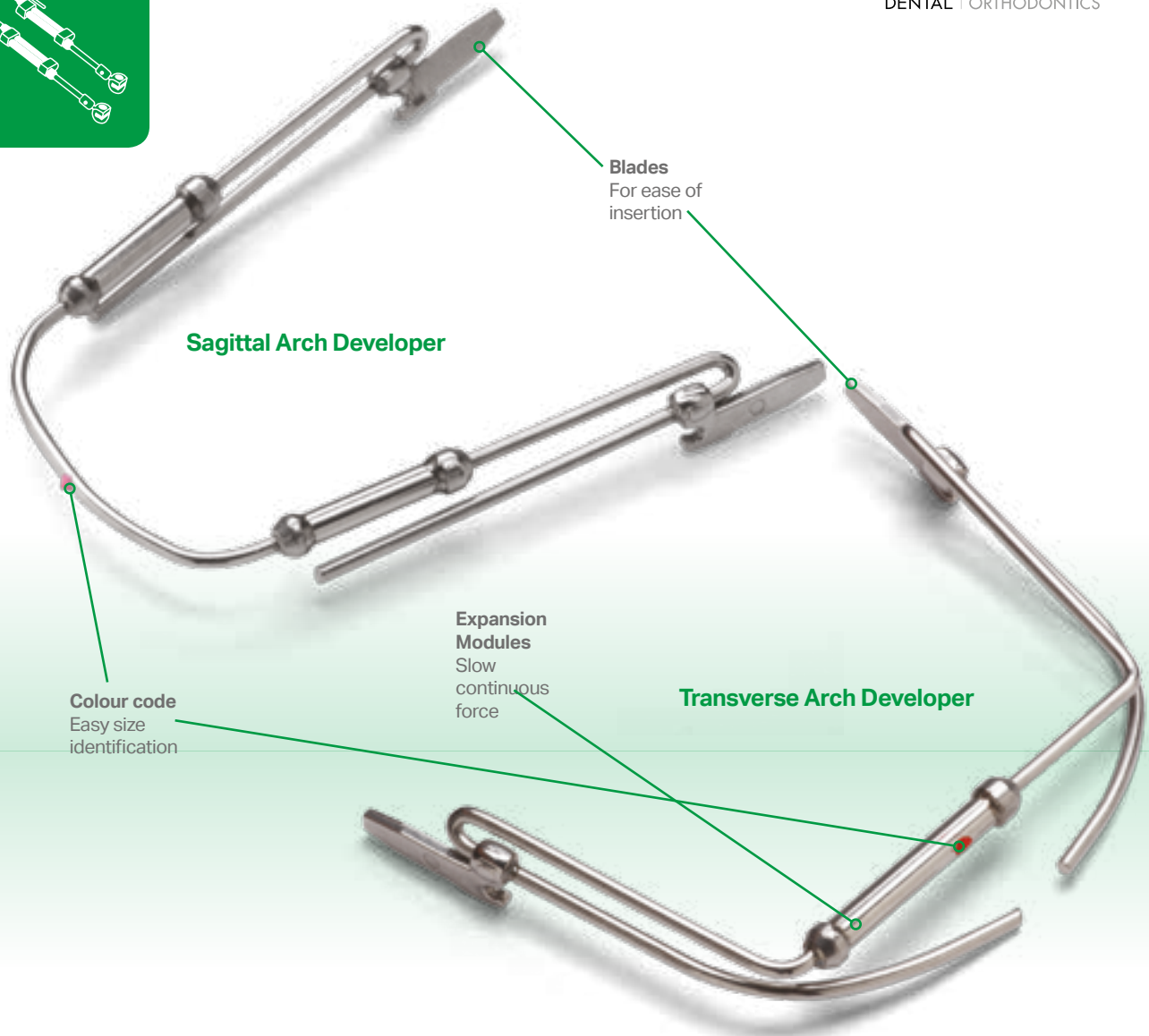
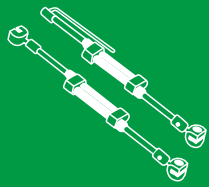

Sagittal Arch Developer

Blades
For ease of insertion

Colour code
Easy size identification

Expansion Modules
Slow continuous force

Transverse Arch Developer

Transforce²

The next generation in expansion

TransForce² Arch Developers are available in two styles, Transverse and Sagittal. Each of these appliances can be used to treat all classes of malocclusion and are excellent for mixed dentition. Both styles mount lingually, making them very inconspicuous and require zero patient compliance. The TransForce² Arch Developer Appliances were developed in consultation with Dr. William J. Clark, the inventor of the Clark Twin Block®.

Virtually Invisible Assistance for Arch Development

Designed for ease of use, the TransForce² Arch Developer Appliances are pre-programmed to allow appliances to be placed without laboratory work. Both the Transverse and Sagittal styles may be placed using first molar bands with standard .036" x .072" lingual sheaths. Each TransForce² Arch Developer Appliance may be easily adjusted per patient. In

TRANSFORCE²
FOR ONLY
£36.99 PER ARCH
Product codes 1164820 - 1164832
Made in the USA

addition, each expander module contains Nitanium Coil Springs generating approximately 200 grams of gentle biocompatible force. The Transverse and Sagittal Appliances are available in multiple sizes, individually or as a starter assortment kit. Best of all, the developers are universal, which allows for less inventory as they can be used for either upper or lower arch development.

Archwires



Cu Nitium 27° Archwires

Cu Nitium® 27° Archwires

ORTHO ORGANIZERS

- 27°C Archwires that provide optimal nickel titanium force levels with the additional flexibility required for easy placement in crowded cases and comfortable tooth movement.
- Innovative thermal properties of copper enhance the Nitium Archwires for a precise control of forces.
- Offers higher resistance to deformation, resulting in fewer wire changes.
- Provides smooth and continuous loading and unloading forces for extended working time.
- Optional stops – packaged pre-threaded on each wire.

Round only £15.99
Rectangular only £17.99

| Cu Nitium 27° | | |
|-------------------|--------------------------------|-------------------------------------|
| | | |
| | Pro Form Arch Shape 10/pack | Oval Arch Form III Shape 10/pack |
| ROUND | £15.99 | £15.99 |
| .014 Lower | 1164025 | 1164085 |
| .014 Upper | 1164024 | 1164084 |
| .016 Lower | 1164027 | 1164087 |
| .016 Upper | 1164026 | 1164086 |
| .018 Lower | 1164029 | 1164089 |
| .018 Upper | 1164028 | 1164088 |
| RECTANGULAR | £17.99 | £17.99 |
| .014 x .025 Lower | 1164031 | 1164091 |
| .014 x .025 Upper | 1164030 | 1164090 |
| .016 x .022 Lower | 1164033 | 1164093 |
| .016 x .022 Upper | 1164032 | 1164092 |
| .016 x .025 Lower | 1164035 | 1164095 |
| .016 x .025 Upper | 1164034 | 1164094 |
| .017 x .025 Lower | 1164037 | 1164097 |
| .017 x .025 Upper | 1164036 | 1164096 |
| .019 x .025 Lower | 1164039 | 1164099 |
| .019 x .025 Upper | 1164038 | 1164098 |

Cu Nitium 35° Archwires

Cu Nitium® 35° Archwires

ORTHO ORGANIZERS

- 35°C archwires activated at body temperature to facilitate easy engagement, consistent forces, and efficient tooth movement using transitional temperature changes back and forth between the “soft” martensite state and “firm” austenite state.
- Innovative thermal properties of copper enhance the Nitium Archwires for a precise control of forces.
- Offers higher resistance to deformation, resulting in fewer wire changes.
- Provides smooth and continuous loading and unloading forces for extended working time.
- Optional stops – packaged pre-threaded on each wire.

Round only £15.99
Rectangular only £17.99

| Cu Nitium 35° | | |
|-------------------|--------------------------------|-------------------------------------|
| | | |
| | Pro Form Arch Shape 10/pack | Oval Arch Form III Shape 10/pack |
| ROUND | £15.99 | £15.99 |
| .016 Lower | 1164041 | 1164101 |
| .016 Upper | 1164040 | 1164100 |
| .018 Lower | 1164043 | 1164103 |
| .018 Upper | 1164042 | 1164102 |
| RECTANGULAR | £17.99 | £17.99 |
| .016 x .022 Lower | 1164045 | 1164105 |
| .016 x .022 Upper | 1164044 | 1164104 |
| .017 x .017 Lower | 1164047 | 1164107 |
| .017 x .017 Upper | 1164046 | 1164106 |
| .017 x .025 Lower | 1164049 | 1164109 |
| .017 x .025 Upper | 1164048 | 1164108 |
| .018 X .025 Lower | 1164051 | 1164111 |
| .018 X .025 Upper | 1164050 | 1164110 |
| .019 x .025 Lower | 1164053 | 1164113 |
| .019 x .025 Upper | 1164052 | 1164112 |
| .020 x .020 Lower | 1164055 | 1164115 |
| .020 x .020 Upper | 1164054 | 1164114 |

Bio-Kinetix Thermal Activated Nitium Archwires

Bio-Kinetix® Thermally Activated Nitium™ Archwires

ORTHO ORGANIZERS

- Heat-activated Nitium archwire specifically designed for consistent performance and low tooth movement.
- Ideal for use during cases that present significant crowding.
- Temperature Transition Range (TTR): 80-90°F (26.7-32.2°C).

Round only £8.99
Rectangular only £16.99

| Bio-Kinetix Thermal Nitium | | |
|----------------------------|--------------------------------|-------------------------------------|
| | | |
| | Pro Form Arch Shape 10/pack | Oval Arch Form III Shape 10/pack |
| ROUND | £8.99 | £8.99 |
| .012 Lower | 1163520 | - |
| .012 Lower | 1163519 | - |
| .014 Lower | 1163523 | 1163676 |
| .014 Upper | 1163521 | 1163675 |
| .016 Lower | 1163527 | 1163678 |
| .016 Upper | 1163525 | 1163677 |
| .018 Lower | 1163531 | 1163680 |
| .018 Upper | 1163529 | 1163679 |
| RECTANGULAR | £16.99 | £16.99 |
| .016 x .016 Lower | 1163534 | 1163682 |
| .016 x .016 Upper | 1163533 | 1163681 |
| .016 x .022 Lower | 1163536 | 1163684 |
| .016 x .022 Upper | 1163535 | 1163683 |
| .017 x .025 Lower | 1163538 | 1163686 |
| .017 x .025 Upper | 1163537 | 1163685 |
| .018 x .025 Lower | 1163541 | - |
| .018 x .025 Upper | 1163539 | - |
| .019 x .025 Lower | 1163544 | 1163690 |
| .019 x .025 Upper | 1163543 | 1163689 |
| .021 x .025 Lower | 1163546 | - |
| .021 x .025 Upper | 1163545 | - |
| .021 x .027 Lower | 1163552 | - |
| .021 x .027 Upper | 1163551 | - |



Nitium Super Elastic Archwires

Super Elastic Nitium® Archwires

ORTHO ORGANIZERS

- Highly flexible and resilient archwire for early to mid stage treatment.

Round only £4.29
Rectangular only £8.49

| Super Elastic Nitium | | |
|----------------------|--------------------------------|-------------------------------------|
| | | |
| | Pro Form Arch Shape 10/pack | Oval Arch Form III Shape 10/pack |
| ROUND | £4.29 | £4.29 |
| .012 Lower | 1163457 | 1163652 |
| .012 Upper | 1163456 | 1163651 |
| .014 Lower | 1166047 | 1163654 |
| .014 Upper | 1166046 | 1163653 |
| .016 Lower | 1166049 | 1163656 |
| .016 Upper | 1166048 | 1163655 |
| .018 Lower | 1166051 | 1163658 |
| .018 Upper | 1166050 | 1163657 |
| .020 Lower | 1163455 | 1163660 |
| .020 Upper | 1163454 | 1163659 |
| RECTANGULAR | £8.49 | £8.49 |
| .016 x .016 Lower | 1163459 | 1163662 |
| .016 x .016 Upper | 1163458 | 1163661 |
| .016 x .022 Lower | 1166053 | 1163664 |
| .016 x .022 Upper | 1166052 | 1163663 |
| .017 x .025 Lower | 1166055 | 1163666 |
| .017 x .025 Upper | 1166054 | 1163665 |
| .018 x .018 Lower | 1163463 | 1163668 |
| .018 x .018 Upper | 1163462 | 1163667 |
| .018 x .025 Lower | 1166057 | 1163670 |
| .018 x .025 Upper | 1166056 | 1163669 |
| .019 x .025 Lower | 1163461 | 1163672 |
| .019 x .025 Upper | 1163460 | 1163671 |
| .020 x .020 Lower | 1163465 | - |
| .020 x .020 Upper | 1163464 | - |
| .021 x .025 Lower | - | 1163673 |
| .021 x .025 Upper | - | 1163674 |

CNA Beta III Archwires

CNA Beta III Nickel-Free Archwires

ORTHO ORGANIZERS

- Nickel-free archwire for an excellent alternative to titanium alloy (TMA) archwires.
- Displays superb formability for placement of loops and bends, reducing important chairside time.
- Ideal to use when the following is required: custom tipping, aligning, space closure, rotation and tooth movement.
- Flexibility means CNA Beta III archwires are particularly effective during mid to late stages of treatment.

Round from £11.19
Saving 20%
Rectangular from £11.19

| CNA Beta III Nickel-Free | | |
|--------------------------|-------------------------------|-------------------------------------|
| | | |
| | Pro Form Arch Shape 5/Pack | Oval Arch Form III Shape 10/Pack |
| ROUND | £11.19 | £23.99 |
| .016 Lower | 1163588 | 1163692 |
| .016 Upper | 1163580 | 1163691 |
| .018 Lower | 1163589 | 1163694 |
| .018 Upper | 1163581 | 1163693 |
| RECTANGULAR | £11.19 | £23.99 |
| .016 x .016 Lower | 1163597 | - |
| .016 x .016 Upper | 1163596 | - |
| .016 x .022 Lower | 1163590 | 1163696 |
| .016 x .022 Upper | 1163582 | 1163695 |
| .017 x .025 Lower | 1163591 | 1163698 |
| .017 x .025 Upper | 1163583 | 1163697 |
| .018 x .018 Lower | 1163592 | 1163700 |
| .018 x .018 Upper | 1163584 | 1163699 |
| .018 x .025 Lower | 1163593 | 1163702 |
| .018 x .025 Upper | 1163585 | 1163701 |
| .019 x .025 Lower | 1163594 | 1163704 |
| .019 x .025 Upper | 1163586 | 1163703 |
| .021 x .025 Lower | 1163595 | - |
| .021 x .025 Upper | 1163587 | - |

Stainless Steel Solid Archwires

Stainless Steel Archwires

ORTHO ORGANIZERS

- Stainless steel archwires specifically designed for use with the Straight Archwire Technique.
- Use throughout entire treatment but best suited for mid to late stages of treatment.

Round only £6.99
Rectangular only £2.69

| Stainless Steel-Bright | | |
|------------------------|---|--|
| | | |
| | Pro Form Arch Shape 50/Pack Rnd 10/Pack Squ | Oval Arch Form III Shape 50/Pack Rnd 10/Pack Squ |
| ROUND | £6.99 | £6.99 |
| .012 Lower | 1163325 | - |
| .012 Upper | 1163324 | - |
| .014 Lower | 1166026 | 1163630 |
| .014 Upper | 1166019 | 1163629 |
| .016 Lower | 1166027 | 1163632 |
| .016 Upper | 1166020 | 1163631 |
| .018 Lower | 1166028 | 1163634 |
| .018 Upper | 1166021 | 1163633 |
| .020 Lower | 1163321 | 1163636 |
| .020 Upper | 1163318 | 1163635 |
| RECTANGULAR | £2.69 | £2.69 |
| .016 x .016 Lower | 1166029 | 1163638 |
| .016 x .016 Upper | 1166022 | 1163637 |
| .016 x .022 Lower | 1166030 | 1163640 |
| .016 x .022 Upper | 1166023 | 1163639 |
| .017 x .025 Lower | 1166031 | 1163642 |
| .017 x .025 Upper | 1166024 | 1163641 |
| .018 x .018 Lower | - | 1163644 |
| .018 x .018 Upper | - | 1163643 |
| .018 x .025 Lower | 1166032 | 1163646 |
| .018 x .025 Upper | 1166025 | 1163645 |
| .019 x .025 Lower | 1163322 | 1163648 |
| .019 x .025 Upper | 1163319 | 1163647 |
| .021 x .025 Lower | 1163323 | 1163650 |
| .021 x .025 Upper | 1163320 | 1163649 |

From only £1.99



Stainless Steel Archwire

HENRY SCHEIN

- All-purpose stainless steel archwires.
- Natural shapes in round, rectangular and square.

Natural Rectangular x 10

Upper Arch .017" x .025" £1.99
1084569

Lower Arch .018" x .025" £1.99
1084570

Upper Arch .018" x .025" £1.99
1084571

Lower Arch .019" x .025" £1.99
1084572

Lower Arch .016" x .022" £1.99
1084573

Lower Arch .017" x .025" £1.99
1084574

Upper Arch .016" x .022" £1.99
1084575

Upper Arch .019" x .025" £1.99
1084576

Natural Square x 10
Lower Arch .016" x .016" £1.99
1084599

Upper Arch .016" x .016" £1.99
1084600

Natural Round x 50
Upper Arch .014" £8.49
9007551

Lower Arch .014" £8.49
9007552

Upper Arch .016" £8.49
9007553

Lower Arch .016" £8.49
9007554

Upper Arch .018" £8.49
9007555

Lower Arch .018" £8.49
9007556

Upper Arch .020" £8.49
9007557

Lower Arch .020" £8.49
9007558

Natural Rectangular x 10
Upper Arch .021" x .025" £1.99
9007559

Lower Arch .021" x .025" £1.99
9007560

Only £24.99



Ligature Rotation Wedge

ORTHO ORGANIZERS

- Elastomeric wedge for correcting rotations.
- Ligate .090" wedge under archwire.
- .012" ligature wire and clear wedge are threaded together.

Wedges .090" x 100
1163386

Only £5.99



Kobayashi Ligature Tie Hooks

ORTHO ORGANIZERS

- Wire is spot welded to form a hook.
- Can be quickly tied in the same manner as ligature wire.

.014 Kobayashi Hooks x 100
1163384

.012 Kobayashi Hooks x 100
1163385

Only £12.99



Short Koby Twists

ORTHO ORGANIZERS

- Preformed ligature wires with twisted ends for rapid engaging and tying to aid quick placement.
- Made from dead soft stainless steel.

Twists .012" x 100
1163389

Twists .014" x 100
1163390

Only £5.99



PearlTone Preformed Ligature Wire

ORTHO ORGANIZERS

- Preformed ligature wire layered with a super smooth, non-stick coating.
- Brackets glide effortlessly along the archwire.

.012 x 100
1163394

Only £8.99



Shorty Ligature Twists

ORTHO ORGANIZERS

- Preformed, ready twisted ligatures for quick and easy placement.
- Made from dead soft stainless steel wire.
- Fit Shorty Twist Holders or Mathieu Needle Holders.

Twists .010" x 500
1163388

Only £9.99



Preformed Ligature Wire

ORTHO ORGANIZERS

- Dead soft temper for maximum work efficiency.
- Preformed to save valuable chair time.

1163381 .009 x 1000

1163382 .010 x 1000

1163383 .011 x 1000

1163387 .012 x 1000



Only £13.99

Nitium 7" Length Open Coil Spring

ORTHO ORGANIZERS

- Spring that can be deflected twice its original length without taking a permanent set.

.010 x .036" Open (Inner diameter) x 3
1163450

.010 x .030" Open (Inner diameter) x 3
1163451

.014 x .036" Open (Inner diameter) x 3
1163452

Only £12.99

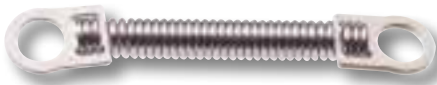

Nitium Closed Coil Springs

ORTHO ORGANIZERS

- Super-elastic nickel titanium springs, designed to open and close spaces with consistent and predictable results.

300 Grams of Force Closing Springs x 4

1163446 .010 x .030" - 12mm

1163447 .010 x .030" - 14mm

1163448 .010 x .030" - 16mm

1163449 .010 x .030" - 18mm

Only £15.49



Nitium Molar Distalizing Spring

ORTHO ORGANIZERS

- Super-elastic springs providing 100 grams of continuous force.
- Fit directly over an archwire when distalising molars.
- Spring attaches to hooks for canine/anterior retraction and can be customised to replace Class II elastics.

1163453 .010 x .045" x 2



Nitium Coil Spring Kit

ORTHO ORGANIZERS

- Super-elastic nickel titanium springs, designed to open and close spaces with consistent and predictable results.
- Perpendicular loop design for easy engaging and removal.

Kit

4 each of Closing Springs .010 x .030" (9 and 12mm), Ligature Closing Springs .010 x .030" (9 and 12mm), 6 each of Open Coil Springs (.010 x .030" 15mm and .010 x .036" 15mm), Dispenser and Storage Case

1163439 **£79.99**

200 Grams of Force Closing Springs x 6

.010 x .030" - 9mm

1163440 **£19.99**

.010 x .030" - 12mm

1163441 **£19.99**

Ligature Closing Springs x 4

.010 x .030" - 9mm

1163442 **£17.99**

.010 x .030" - 12mm

1163443 **£17.99**

Open Coil Springs x 10

.010 x .030" - 15mm

1163444 **£14.99**

.010 x .036" - 15mm

1163445 **£14.99**

Only £16.99



Nitium Separating Springs

ORTHO ORGANIZERS

- Separating springs providing a light, consistent force for optimum space opening in minimum time.
- Easy to place and self-seating.
- Simple to remove once sufficient space for banding is achieved.
- Comfortable for patients.

Springs x 20

Small (Bicuspid)

1163466

Large (Molars)

1163467

Only £9.99



Nitium Spooled Open Coil Spring

ORTHO ORGANIZERS

- Super-elastic open coil springs providing constant tooth movement.
- Efficient in opening spaces when placed on archwire and compressed between brackets.
- Gentle for patients.

15" Spool

.009 x .030" Open (Inner Diameter)

1163487

.010 x .030" Open (Inner Diameter)

1163488

.012 x .030" Open (Inner Diameter)

1163489

.014 x .030" Open (Inner Diameter)

1163490

.010 x .036" Open (Inner Diameter)

1163491

.014 x .036" Open (Inner Diameter)

1163492

.010 x .045" Open (Inner Diameter)

1163493

.012 x .045" Open (Inner Diameter)

1163494

Only £19.99



Nitium Variable Force Spring

ORTHO ORGANIZERS

- Fixed Class II spring for patients who do not use their elastics.

.020 x .100" x 4

1163468

From only **£3.39**



Spoiled Open and Closed Coil Springs

ORTHO ORGANIZERS

- Stainless steel, hard, tempered wire springs for opening and closing space.

Open Coil Spring 3" Spool

| | | |
|---------|--------------|-------|
| 1163925 | .010 x .030" | £3.79 |
| 1163926 | .010 x .036" | £3.79 |

Closed Coil Spring 3" Spool

| | | |
|---------|--------------|-------|
| 1163927 | .010 x .030" | £3.79 |
|---------|--------------|-------|

Open Coil Spring 3" Spool

| | | |
|---------|--------------|-------|
| 1163995 | .009 x .040" | £3.39 |
| 1163996 | .010 x .045" | £5.39 |
| 1163997 | .007 x .025" | £3.39 |

Only **£10.99**



Crimpable Archwire Tubes with Hooks

ORTHO ORGANIZERS

- Crimpable archwire tubes that provide a firm anchor point for a variety of applications.
- Position anywhere on an archwire by threading the archwire through the tube before engaging the brackets.
- The tube can then be locked securely into position by crimping it with How Pliers or a dull archwire cutter.

| | |
|---------|------------------|
| 1164905 | .017 x .025 x 10 |
| 1164906 | .019 x .025 x 10 |

From only **£14.99**



Crimpable Archwire Hooks

ORTHO ORGANIZERS

- Precision-MIM crimpable hooks, easily crimped onto archwire for precise placement in or outside the mouth.
- Crimp tubes create a strong, non-sliding lock with the archwire and remain firmly in place during treatment.

| | |
|--------------------------|--------|
| Ball Hooks x 20 | |
| 1166162 | £14.99 |
| Power Hooks - Right x 20 | |
| 1166163 | £16.99 |
| Power Hooks - Left x 20 | |
| 1166164 | £16.99 |

Supporting professional development through CPD.

Updating your skills, understanding the latest technology and being familiar with practice compliant requirements are all vital in an ever-changing dental environment.

Henry Schein Dental Education is committed to ensuring the highest quality in all aspects of their CPD provision and is certified by the BDIA's new Code of Practice.

All seminars, conferences, training and workshop sessions have clear learning outcomes for verifiable CPD.

Visit hsdeducation.co.uk for access to upcoming course information.





MAXIMA INSTRUMENTS
BUY 2 GET
1 FREE*
 *Mix & Match, lowest priced item sent free

Maxima[®] Orthodontic Pliers

HENRY SCHEIN[®] BRAND



Micro Mini Pin & Ligature Cutter Long Handle
9007606 £60.29



Distal End Cutter Safety Hold Long Handle
9007600 £60.29



How Pliers
9007609 £60.29



Micro Mini Pin & Ligature Cutter, 15°
9007607 £60.29



Micro Cutter
9007604 £60.29



Light Wire Bird Beak Pliers
9007617 £60.29



Distal End Cutter Safety Hold
9007599 £60.29



Multi-Use Cutter
9007603 £60.29



Detailing Step Pliers 1mm
9007629 £60.29



Hard Wire Cutter 15
9007602 £60.29



Distal End Cutter Safety Hold & Flush Cut
9007601 £60.29



Lingual Arch Forming Pliers
9007630 £60.29



Adams Pliers
9007625 £60.29



Micro Mini Pin & Ligature Cutter
9007605 £60.29



Tweed Loop Forming Pliers
9007621 £60.29



Debonding Pliers
9007612

£60.29



Angulated Debonding Pliers
9007613

£55.29



Posterior Band Removing Pliers - Long
9007611

£55.29



Hook Crimping Pliers (Angled)
9007632

£60.29



Bird Beak Pliers
9007615

£60.29



Adhesive Removing Pliers
9007610

£60.29



Distal Cinch Back Pliers
9007634

£60.29



Stop (V-Bend) Pliers
9007631

£60.29



Mini Three Jaw Pliers
9007620

£60.29



Crown & Band Contouring Pliers
9007633

£60.29



Angulated Debonding Pliers
9007613

£60.29



Three Jaw Pliers
9007619

£60.29



Jarabak Pliers
9007614

£60.29



Light Wire Bird Beak with Groove
9007618

£60.29



Detailing Step Pliers 0.75mm
9007628

£60.29



Torquing Pliers Set
9007635

£60.29



Nance Loop Forming Pliers
9007627

£60.29



Optical Pliers
9007622

£60.29



Loop Tie Back Pliers
9007626

£60.29



Slim Weingart Pliers
9007608

£60.29



Arch Bending Pliers
9007623

£60.29

Hu-Friedy
**HU-FRIEDY PLIERS
BUY 1 GET
1 HALF PRICE***

For full range of pliers please call 01634 266 060

*Pliers must be of the same or lesser value

Hu-Friedy Orthodontic Instruments

Hu-Friedy's Clear Collection consists of innovative instruments designed to accent, individualise and optimise the biomechanics of the 'invisible' aligner experience.



Clear Collection - The Hole Punch

HU-FRIEDY

- The Hole Punch creates half-moon cutouts for relief of clear aligners around bonded buttons used for elastics.

The Hole Punch 678-803

1166361

£125.99



Clear Collection - The Vertical

HU-FRIEDY

- The Vertical emphasises over-correction of rotations by producing an indentation at the mesial or distal line angles on the facial and/or lingual of a specific tooth.

The Vertical 678-801

1166359

£109.99



Clear Collection - The Tear Drop

HU-FRIEDY

- The Tear Drop creates a notch at the gingival margin of clear aligners anywhere elastic hooks are required within the arch.

The Tear Drop 678-800

1166358

£125.99



Slim Collection Flush Cut & Hold Distal End Cutter

HU-FRIEDY

- True flush cut and hold instrument featuring a 50% reduced working end that enhances visibility.

Slim Flush Cut & Hold Distal End Cutter 678-113

1166295

£125.99



Weingart Pliers

HU-FRIEDY

- Versatile utility pliers with serrations.
- Tapered, angular design is convenient for placement and removal of archwires.

Weingart Pliers Slim 20° 678-202

1166298

£109.99



Coon Style Ligature Tying Pliers

HU-FRIEDY

- Popular pliers for tying stainless steel wires.
- Wire size: .015" (.38mm).

Coon Style Ligature Tying Pliers 678-211

1166305

£109.99



Lingual Arch Forming Pliers

HU-FRIEDY

- Designed to create double back and triple back bends in .030 and .036" lingual arch wires.

Lingual Arch Forming Pliers 678-309

1166321

£109.99



Angulated Bracket Removing Pliers

HU-FRIEDY

- High angle design in long handle is effective for removal of all bracket styles from anterior and posterior teeth.

Angulated Bracket Removing Pliers 678-220L

1166308

£109.99



Old Style Loop Pliers

HU-FRIEDY

- Provides optimum accuracy and precision in forming and closing loops with one cylindrical three-step beak and one triangular beak.

Old Style Loop Pliers 678-324

1166331

£109.99



Tip Back Pliers

HU-FRIEDY

- Bends down the distal extension of an archwire protruding past the buccal tube.
- Innovative contra-angle design allows for easy intraoral access.
- Wire size: .022 x .025" (.53 x .64mm).

Tip Back Pliers with Long Handle 678-216
1166307 £109.99



Jarabak Pliers

HU-FRIEDY

- Versatile light wire bending pliers.
- Grooves assist with precise bending and closing of loops.
- Serrated surface grips wires.
- Wire size: .020" (.51mm).

Jarabak Pliers 678-301
1166315 £109.99



NiTi Three Jaw Pliers

HU-FRIEDY

- Designed for forming and contouring of all archwire, especially for NiTi.
- Wire size: .020" (.51mm).

NiTi Three Jaw Pliers 678-322
1166329 £109.99



Band Seating Pliers

HU-FRIEDY

- Serrated tips grip brackets to assist in placing bands.

Band Seating Pliers 678-205
1166301 £109.99



Optical Pliers

HU-FRIEDY

- Excellent for forming helical closing loops and arch adjustments.
- Wire size: .022 x .025" (.53 x .64mm).

Optical Pliers 678-323
1166330 £109.99



Universal Cut & Hold Distal End Cutter

HU-FRIEDY

Distal End Cutter .012 to .021 x .025" (.30 to .53 x 64mm) 678-101

771201 £130.99

Distal End Cutter with Long Handle .012 to .021 x .025" (.30 to .53 x .64mm) 678-101L

1166286 £125.99



Crown & Band Contouring Pliers

HU-FRIEDY

- Designed for fitting of stainless steel crowns and bands.

Pliers 678-221
1166309 £109.99

Pliers Slim Modified 678-221M
1166310 £109.99

Pliers Modified 678-221MC
1166311 £109.99



Arch Bending Pliers

HU-FRIEDY

- Designed for placing first, second and third order bends.
- Wire size: .022 x .025" (.53 x .64mm).

Arch Bending Pliers .050" Blade Width 678-307
1166319 £109.99

Tweed Pliers Slim .025" Blade Width 678-307S
1166320 £109.99



Hammerhead® NiTi Tip-Back Pliers

HU-FRIEDY

- Multi-use NiTi bender.
- Tie-back NiTi with no heat.
- Wire size: .025" (.63mm).

Hammerhead NiTi Tie-Back Pliers 678-327
1166334 £109.99

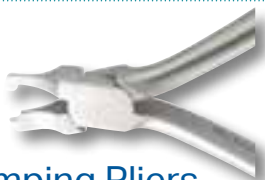

Band Crimping Pliers

HU-FRIEDY

- Thin tips allow for access into molar and bicuspid bands.

Band Crimping Pliers 678-225
1166313 £109.99

Band Crimping Pliers with Spring 678-225M
1166314 £109.99



General Contouring Pliers

HU-FRIEDY

General Contouring Pliers 678-315
1166323 £109.99



Torquing Pliers with Key

HU-FRIEDY

Torquing Pliers With Key .016 x .018" 678-328-20
1166335 £109.99

Torquing Pliers With Key .018 x .022" 678-328-21
1166336 £109.99



Hu-Friedy



Weingart Pliers

HU-FRIEDY

- Versatile utility pliers with serrations.
- Tapered, angular design is convenient for placement and removal of archwires.

Weingart Pliers Ultra Slim 678-200

1166296 £116.29

Weingart Pliers with Long Handle 32° 678-201L

1166297 £109.99

Weingart Pliers Slim 20° 678-202

1166298 £109.99



Lingual Pliers

HU-FRIEDY

Lingual Distal End Cutter 678-700
(Wire Size: .012-.018")

1166347 £151.29

Lingual Pin & Ligature Cutter 678-701
(Wire Size: .012")

1166348 £151.29

Lingual Weingart Pliers 678-702
(Wire Size: .030")

1166349 £132.29

Lingual Weingart Pliers 90° 678-702-90
(Wire Size: .030")

1166350 £132.29

Lingual Bracket Removing Pliers 678-703

1166351 £132.29

Lingual Hammerhead NiTi Pliers 678-704
(Wire Size: .025")

1166352 £132.29

Lingual Hammerhead NiTi Pliers Serrated
678-704SER (Wire Size: .025")

1166353 £132.29

Lingual Mathieu Pliers 678-705 (Wire Size:
.015")

1166354 £124.99

Lingual Ligature Director 678-706 (Wire Size:
.021 x .025")

1166355 £58.29

Lingual Ligature Director - U Shape 678-707
(Wire Size: .021 x .025")

1166356 £58.29

Lingual Torquing Key With Picker - U Shape
678-708 (Wire Size: .018")

1166357 £48.49



Hard Wire Cutter 15° Angled

HU-FRIEDY

- Cutter with a 15° offset tip enhancing access to difficult areas.
- Designed to cut hard wires.
- Wire size: .022 x .028" (.56 x .71mm).

Hard Wire Cutter 15° Angled 678-103

1166288 £125.99



Three Jaw Pliers

HU-FRIEDY

- Useful for contouring and bending wire.
- Wire size: .030" (.76mm).

Three Jaw Pliers 678-302

1166316 £109.99



Slim Collection Band Removing Pliers

HU-FRIEDY

- Features a 21% thinner and more tapered working end designed to reduce patient discomfort.

Slim Band Removing Pliers 678-503

1166343 £109.99



Force Module Separating Pliers

HU-FRIEDY

- Used for placement of elastic separators.

Force Module Separating Pliers 678-210

1166304 £109.99



Omega Loop Forming Pliers

HU-FRIEDY

- Graduated cone is designed to form precise omega loops: .045, .060 and .075".
- Wire size: .022 x .025" (.53 x .64mm).

Omega Loop Forming Pliers 678-303

1166317 £109.99



Ortho Mathieu Perma Sharp® Pliers

HU-FRIEDY

- Thin tips made with carbide inserts.

Ortho Mathieu Perma Sharp Pliers 678-332

1166339 £103.99



Posterior Band Removing Pliers

HU-FRIEDY

- The alignment of the tip and occlusal pad is well suited for posterior band removal.

Posterior Band Removing Pliers Long 678-207

1166303 £109.99



Ortho Mathieu Wide Tip Pliers

HU-FRIEDY

- With wider, stronger tips.

Ortho Mathieu Wide Tip Pliers 678-331

1166338 £103.99



Bird Beak Pliers

HU-FRIEDY

- Versatile loop-forming pliers for round wires.
- Wire size: .030" (.76mm).

Bird Beak Pliers 678-304

1166318

£109.99



Hollow Chop Pliers

HU-FRIEDY

- For subtle contouring of archwires with reduced radius compared to Hollow Chop Contouring Pliers.
- Wire size: .030" (.76mm).

Hollow Chop Pliers 678-317

1166325

£109.99



V-Stop Pliers

HU-FRIEDY

- Places V bend in archwires, including nickel titanium, to prevent archwire from travelling.
- Wire size: .022 x .025" (.53 x .64mm).

V-Stop Pliers 678-321

1166328

£109.99

**Buy 3 get 1 FREE
Only £44.79**



Orthodontic Hand Instruments

HU-FRIEDY

- Hu-Friedy orthodontic hand instruments are finely tuned to achieve accurate weight, balance and tip alignment.

AOT Bracket Ligator Handle No 6 678-903

1166362

Scaler/Band Pusher Handle No 6 678-904

1166363

Ligature Director Scaler Handle No 6 678-905

1166364

Dull Scaler/Band Pusher Handle No 6 678-906

1166365

Small Plugger/Picker Handle No 6 678-907

1166366

Plugger/Very Small Picker Handle No 6 678-907S

1166367

Ligature Director/Band Pusher Handle No 6 678-908

1166368

Large Plugger/Picker Handle No 6 678-909

1166369

Dull Scaler H5/#3 Jaquette Handle No 6 678-910

1166370

Dull Scaler SH6/SH7 Handle No 6 678-911

1166371

Ligature Director/Band Pusher Handle No 6 678-912

1166372

Dull Scaler Towner U15 Handle No 6 678-913

1166373

Picker/Ligature Director Handle No 6 678-916

1166374



Marcotte Looping Pliers

HU-FRIEDY

- For precise forming of helical loops and T loops.
- No right angles.
- Prevents stress fracture of wires.
- Wire size: .022 x .025" (.53 x .64mm).

Marcotte Looping Pliers 678-316

1166324

£109.99

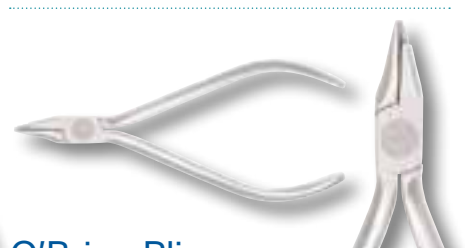

O'Brien Pliers

HU-FRIEDY

- For precise forming of small helical loops and intraoral tip back bends.
- Wire size: .020" (.51mm).

O'Brien Pliers 678-311

1166322

£109.99

**Was £145.79
Only £122.29**

IMS DIN Orthodontic Cassette

HU-FRIEDY

- Signature Series® orthodontic cassette designed to keep instruments organised and intact from cleaning to chairside.

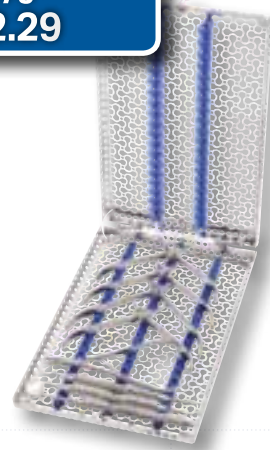

290 x 184 x 34mm

- 1132535 Blue
- 1166376 Ocean Blue
- 1166377 Red
- 1166378 Grey
- 1166379 White
- 1166380 Orange
- 1166381 Purple
- 1166382 Yellow
- 1166383 Lavender
- 1166384 Black
- 1166386 Green

From only £131.79



IMS Thin Ortho Cassettes

HU-FRIEDY

- IMS cassettes are made of long-lasting, low maintenance stainless steel.
- Soft, coloured rails securely hold instruments throughout the processing cycle.

Large Blue (W)280 x (D)203 x (H)19mm

1166387 £151.29

Small Blue (W)203 x (D)178 x (H)19mm

1166388 £131.79

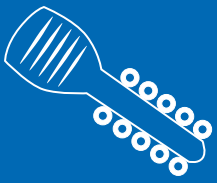

**LIGATURE TIES
FROM ONLY
£5.99**

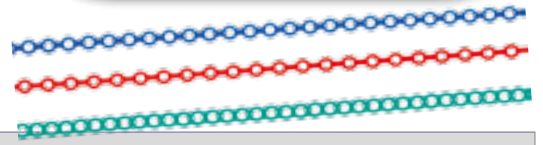

Ligature Ties

ORTHO ORGANIZERS

| Colour/Description | | Ring-Tie | O-Tie | Mini-O-Tie | 15' Chain | | |
|--------------------|-----------------|----------|---------|------------|-----------|----------|------------|
| Quantity | | 30 | 30 | 50 | | | |
| Colour | Name | .120" | .120" | .120" | Short | Standard | Continuous |
| | | £5.99 | £5.99 | £7.99 | £5.99 | £5.99 | £5.99 |
| | Grey | 1166095 | 1164696 | 1164659 | - | 1166080 | 1166081 |
| | Clear | 1166092 | 1164663 | 1164627 | 1164439 | 1166077 | 1166083 |
| | White | 1164703 | 1164670 | 1164634 | 1164443 | 1164400 | - |
| | Blue | 1164701 | 1164667 | 1164631 | 1164490 | 1164398 | 1164469 |
| | Green | 1164704 | 1164671 | 1164635 | 1164468 | - | 1164485 |
| | Neon Pink | 1166093 | 1164664 | 1164628 | 1164484 | 1166078 | 1166085 |
| | Black | 1166094 | 1164668 | 1164632 | 1164460 | 1166079 | 1166086 |
| | Purple | 1164699 | 1164665 | 1164629 | 1164463 | 1164396 | 1164462 |
| | Red | 1164700 | 1164666 | 1164630 | 1164461 | 1164397 | 1164482 |
| | Yellow | 1164702 | 1164669 | 1164633 | 1164481 | 1164399 | 1164466 |
| | Orange | 1164711 | 1164678 | 1164642 | 1164465 | 1164411 | 1164500 |
| | Teal | 1164712 | 1164679 | 1164643 | 1164499 | 1164412 | 1164554 |
| | Pearl | 1164728 | 1164695 | 1164658 | 1164553 | 1164429 | 1164512 |
| | Vanilla | 1164713 | 1164680 | 1164644 | 1164511 | 1164413 | 1164455 |
| | Neon Blue | 1164705 | 1164672 | 1164636 | 1164454 | 1164402 | 1164557 |
| | Neon Green | 1164714 | 1164681 | 1164645 | - | 1164414 | 1164458 |
| | Gold | 1164706 | 1164673 | 1164637 | 1164457 | 1164403 | 1164479 |
| | Silver | 1166091 | 1164662 | 1164626 | 1164478 | 1166076 | 1166089 |
| | Smoke | 1164715 | 1164682 | 1164646 | 1164477 | 1164415 | 1164560 |
| | Burgundy | 1164707 | 1164674 | 1164638 | 1164559 | 1164404 | 1164488 |
| | Glow Natural | 1164725 | 1164692 | 1164655 | 1164487 | 1164427 | 1164502 |
| | Glow Pink | 1164726 | 1164693 | - | - | - | 1164506 |
| | Glow Blue | 1164724 | 1164691 | - | - | 1164424 | - |
| | Carolina Blue | 1164709 | 1164676 | 1164640 | 1164503 | 1164407 | - |
| | Cobalt Blue | 1164729 | 1164697 | 1164660 | 1164505 | 1164430 | 1164587 |
| | Periwinkle | 1164710 | 1164677 | 1164641 | 1164586 | 1164408 | 1164509 |
| | Metallic Green | 1164716 | 1164683 | 1164647 | 1164508 | 1164416 | 1164563 |
| | Metallic Blue | 1164717 | 1164684 | 1164648 | 1164562 | 1164417 | 1164494 |
| | Metallic Purple | 1164730 | 1164698 | 1164661 | 1164493 | 1164431 | 1164584 |
| | Metallic Red | 1164718 | 1164685 | 1164649 | 1164583 | 1164418 | 1164497 |
| | Grape | 1164719 | 1164686 | 1164650 | 1164496 | 1164419 | 1164566 |
| | Light Pink | 1164720 | 1164687 | 1164651 | 1164565 | 1164420 | 1164569 |
| | Light Green | 1164721 | 1164688 | 1164652 | 1164568 | 1164421 | 1164572 |
| | Dark Blue | 1164722 | 1164689 | 1164653 | 1164571 | 1164422 | 1164575 |
| | Raspberry | 1164723 | 1164690 | 1164654 | 1164574 | 1164423 | 1164578 |
| | Sky Blue | 1164727 | 1164694 | 1164657 | 1164577 | 1164428 | 1164581 |
| Assorted Colour | | 1164708 | 1164675 | 1164639 | - | - | - |

Smile Safari™ Intraoral Elastics

ORTHO ORGANIZERS

- Made from the finest amber-coloured surgical latex tubing, precision-cut to separate each elastic.
- Colour-coded for easy identification.
- Packaged in tamper-proof patient bags.

Only £14.99

Smile Safari™ Intraoral Elastics Chart

| | Light - 2.5 oz | Medium - 4.5 oz | Heavy - 6.5 oz |
|-------|--|---|---|
| 1/8" | | | |
| | Giraffe 1/8" (3.2 mm) Light 2.5 oz | Chimpanzee 1/8" (3.2 mm) Medium 4.5 oz | Python 1/8" (3.2 mm) Heavy 6.5 oz |
| 3/16" | | | |
| | Toucan 3/16" (4.8 mm) Light 2.5 oz | Zebra 3/16" (4.8 mm) Medium 4.5 oz | Elephant 3/16" (4.8 mm) Heavy 6.5 oz |
| 1/4" | | | |
| | Gazelle 1/4" (6.4 mm) Light 2.5 oz | Lion 1/4" (6.4 mm) Medium 4.5 oz | Rhino 1/4" (6.4 mm) Heavy 6.5 oz |
| 5/16" | | | |
| | Leopard 5/16" (7.9 mm) Light 2.5 oz | Gorilla 5/16" (7.9 mm) Medium 4.5 oz | Hippo 5/16" (7.9 mm) Heavy 6.5 oz |
| 3/8" | | | |
| | Vulture 3/8" (9.4 mm) Light 2.5 oz | Warthog 3/8" (9.4 mm) Medium 4.5 oz | Crocodile 3/8" (9.4 mm) Heavy 6.5 oz |

760.448.8600
888.851.0533

| Amber - Prepackaged Intraoral Elastics: 1 Box (Approx. 100 Elastics per Bag) | | | | 50 Bags per Box | 50 bags per zip-lock bag |
|---|---------------|------------|------------|-----------------|--------------------------|
| Size | Weight | Name | Bag Colour | Code | Code |
| 1/8" (3.2mm) | Light (2½oz) | Giraffe | Purple | 1166097 | 1164761 |
| 1/8" (3.2mm) | Medium (4½oz) | Chimpanzee | Purple | 1166098 | 1164762 |
| 1/8" (3.2mm) | Heavy (6½oz) | Python | Purple | 1166099 | 1164763 |
| 3/16" (4.8mm) | Light (2½oz) | Toucan | Green | 1166100 | 1164764 |
| 3/16" (4.8mm) | Medium (4½oz) | Zebra | Green | 1166101 | 1164765 |
| 3/16" (4.8mm) | Heavy (6½oz) | Elephant | Green | 1166102 | 1164766 |
| 1/4" (6.4mm) | Light (2½oz) | Gazelle | Red | 1166103 | 1164767 |
| 1/4" (6.4mm) | Medium (4½oz) | Lion | Red | 1166104 | 1164768 |
| 1/4" (6.4mm) | Heavy (6½oz) | Rhino | Red | 1166105 | 1164769 |
| 5/16" (7.9mm) | Light (2½oz) | Leopard | Blue | 1166106 | 1164770 |
| 5/16" (7.9mm) | Medium (4½oz) | Gorilla | Blue | 1166107 | 1164771 |
| 5/16" (7.9mm) | Heavy (6½oz) | Hippo | Blue | 1166108 | 1164772 |
| 3/8" (9.4mm) | Light (2½oz) | Vulture | Orange | 1166109 | 1164773 |
| 3/8" (9.4mm) | Medium (4½oz) | Warthog | Orange | 1166110 | 1164774 |
| 3/8" (9.4mm) | Heavy (6½oz) | Crocodile | Orange | 1166111 | 1164775 |

Only £3.99



Tissue Guard

ORTHO ORGANIZERS

- Used to slip over the archwire to prevent irritations.
- Aesthetic in appearance, odour and stain resistant.
- Fits wires up to .045".
- Non-latex.

10' Spool

| | |
|---------|------------|
| 1164448 | Clear .018 |
| 1164449 | Grey .018 |
| 1164450 | Clear .046 |
| 1164451 | Grey .046 |
| 1164452 | Clear .027 |
| 1164453 | Grey .027 |

Only £5.99



Chain Elastic

ORTHO ORGANIZERS

- Non-latex light force chain elastic for force treatment mechanics.
- Thinner chain material is easier to apply, reducing chair time.

Continuous 15'

1164438 Grey

Short 15'

1164440 Grey

Long 15'

1164441 Grey

Continuous 15'

1164442 Clear

Short 15'

1164444 Clear

Long 15'

1164445 Clear

Only £6.49



Stick Separators

ORTHO ORGANIZERS

- Designed with smooth, round edges that make them easier to insert between teeth.
- Made of radiopaque material and conveniently moulded on sticks for easy handling.
- Non-latex.

Stick Separators

10 Separators per Stick x 25
1164476

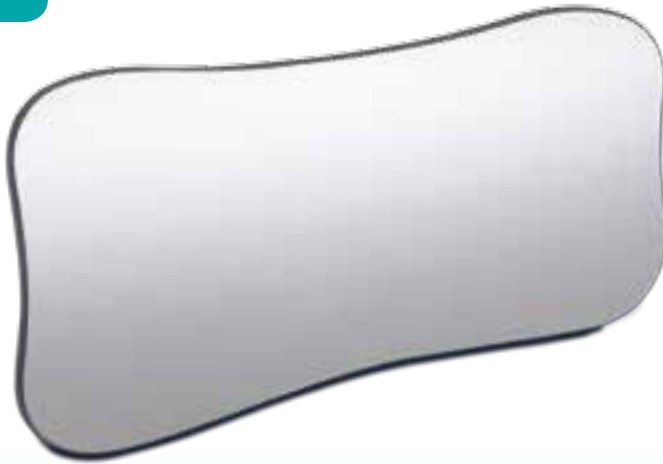

Highest Reflectivity

- Clear, sharper images with rhodium-coated mirrors
- Up to 10% more reflectivity than chrome mirrors
- Up to 20% more reflectivity than metal mirrors

Highest Quality

- Dual-sided mirror meaning twice the life of single-sided mirrors
- More durability from flatter, higher quality substrate, which allows better adhesion of rhodium coating to provide outstanding wear resistance
- Able to withstand repeated autoclave cycles up to 350°F/180°C. Brackets not needed

Patient Comfort

- Thicker mirrors with rounded corners make these more comfortable in the patient's mouth
- Both adult and pediatric sizes - makes it easy to pick the right shape for your patient

Riofoto

Rhodium-Coated Intraoral Photography Mirrors

Improve Your Image

All photographic mirrors are not the same. Mirrors coated with rhodium, a silvery-white precious metal, provide clearer, brighter images that will produce higher quality dental pictures. Superior quality pictures are an excellent tool to help improve clinical effectiveness as they may be used to promote patient education and help explain why major restorative treatment is necessary. They also provide documentation for patient records, insurance claims and case presentations to colleagues. A quality picture really is worth a thousand words!

Riofoto Rhodium Mirrors

ORTHO ORGANIZERS

- Rhodium-coated mirrors for clearer, sharper images.
- Dual-sided for increased life.
- Thick, rounded corners for patient comfort.
- Autoclavable up to 350°F/180°C.

Standard Kit

Palatal (Adult), Palatal (Child), Lingual (Narrow Inside), Lingual (Wide Inside), Buccal (Narrow Outside) and Buccal (Wide Outside) x 1 each

1165029 **£239.99**

**Was £48.99
Now only £38.49**

- | | |
|-------------------------|---------------------------------|
| 1166176 X-Long (Adult) | 1166180 Lingual (Narrow Inside) |
| 1166177 X-Long (Child) | 1166181 Lingual (Wide Inside) |
| 1166178 Palatal (Adult) | 1166182 Buccal (Narrow Outside) |
| 1166179 Palatal (Child) | 1166183 Buccal (Wide Outside) |

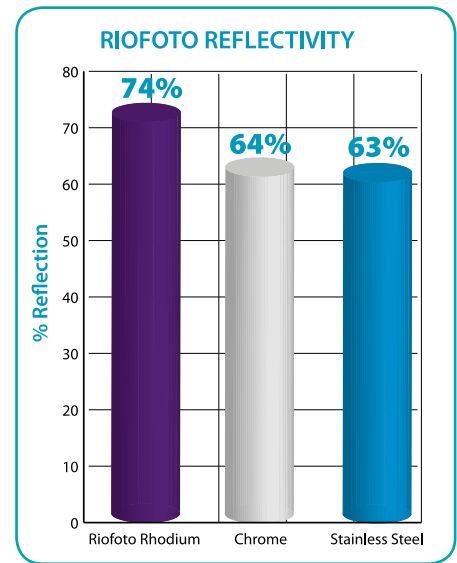

Was £43.79
Only £34.99

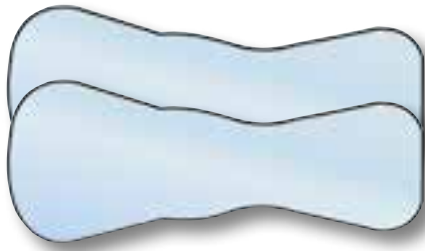

Photographic Stainless Steel Mirrors

ORTHO ORGANIZERS

- Photographic mirrors coated with shiny, stainless steel material for clear reflected images with natural colour.
- Alloy hardened base will not shatter, chip or break if dropped.
- Smooth radiused surfaces.

Adult Occlusal/Child Occlusal
1166169

Buccal Lateral
1166170

Adult Occlusal/Child Occlusal
1166171

Adult Buccal/Adult Occlusal
1166172

Lingual Upper/Lingual Lower
1166173

Child Buccal/Adult Buccal
1166174

Child Occlusal/Child Buccal
1166175

Was £9.29
Only £6.12

Aligner Chewies

HENRY SCHEIN

- Soft plastic rolls to help the patient seat aligner properly.

10 x 2 packs

9882203 Mint

9882204 Unscented

9882205 Pineapple



Only £6.99



Separating Abrasive Strips

ORTHO ORGANIZERS

- Durable diamond abrasive strips, electronically bonded to surgical grade steel base to resist stretching.
- For reducing and/or shaping the interproximal area.

Strip Holder

1163935 £18.99

Strips .003" x 10

1163936 4mm Fine

1163937 4mm Medium

1163938 4mm Double-Sided Medium

1163939 4mm Coarse

1163940 6mm Fine

1163941 6mm Medium

1163942 6mm Double-Sided Medium

1163943 6mm Coarse

1163944 8mm Medium

1163945 8mm Double-Sided Medium

1163946 8mm Coarse

Only £16.99



Orthodontic Relief Wax

ORTHO ORGANIZERS

- For patients' emergency use when appliance is irritating soft tissue.
- Easy to apply, providing immediate temporary relief.

Wax - Box of 50 Cases

1164364 Regular (Clear Case Unscented)

1164365 Bubblegum Scent (Pink Case)

1164366 Cherry Scent (Red Case)

1164367 Lemon Scent (Yellow Case)

1164368 Orange Scent (Orange Case)

1164369 Mint Flavoured (Clear Case)

Buy 1 get 1 FREE



Ortho Mouthguards Latex-Free

HENRY SCHEIN

- Simple mouthguard to protect patient from soft tissue impingement.
- Hinged design allows for easy breathing and talking.

Translucent Adult x 12

1084849 £18.49

Translucent Child x 12

1084850 £18.49

HENRY SCHEIN®
Business Solutions

Business solutions.

We offer a range of products and services to increase revenue, reduce costs and improve profitability.

Please visit hsbusinesssolutions.co.uk for more information.



Only £19.99



Ultraguard Mouthguards

ORTHO ORGANIZERS

- Ideal for athletes with braces and useful for all sports.

Without Strap x 10

| | |
|---------|----------|
| 1165069 | Assorted |
| 1165070 | Red |
| 1165071 | Green |
| 1165072 | Yellow |
| 1165073 | Blue |
| 1165074 | Black |
| 1165075 | Clear |

**Was £4.99
Only £3.29**



Retainer Brite

ORTHO CARE UK LTD

- Cleans and brightens removable dental appliances such as retainers, aligners and nightguards.
- Kills 99.9% of odour causing bacteria.
- Helps remove tartar and plaque.
- Keeps appliances fresh and clean.
- Strong against stubborn stains.

1098735 Cleaning Tablets x 36

Only £22.99



Model Boxes

GREYHOUND

- Model storage.
- Manufactured from high-quality card.

Manilla Boxes x 12

| | |
|--------------------------------|--------|
| (W)75 x (H)75 x (D)205mm | |
| 900825 | £22.99 |
| (W)75 x (H)75 x (D)235mm | |
| 900826 | £22.99 |
| (W)75 x (H)75 x (D)280mm | |
| 900827 | £22.99 |
| Green (W)234 x (H)80 x (D)70mm | |
| 900828 | £2.99 |

Buy 1 get 1 FREE

Retainer Boxes Deep Dish



HENRY SCHEIN

- Sturdy and deep retainer box that holds oversized retainers.
- 3 x 2½ x 1½" deep.

Retainer Boxes x 10

| | | |
|---------|--------------------|-------|
| 1083996 | Black | £5.39 |
| 1083997 | Purple | £5.39 |
| 1083998 | Fire Orange | £5.39 |
| 1083999 | Red | £5.39 |
| 1084000 | Light Pink | £5.39 |
| 1084001 | Yellow | £5.39 |
| 1084002 | Green | £5.39 |
| 1084003 | Blue | £5.39 |
| 1084004 | White | £5.39 |
| 1084005 | Fluorescent Orange | £5.39 |
| 1084006 | Fluorescent Green | £5.39 |
| 1084007 | Fluorescent Pink | £5.39 |

Retainer Boxes x 12

| | | |
|---------|------------------|-------|
| 1084008 | Assorted Colours | £6.09 |
|---------|------------------|-------|

Ordering is easy



Phone | PC | Tablet

For more information visit www.henryschein.co.uk

Free delivery online

Education.

For more information on the latest education courses to support you, your employees and practice.

Visit hsdeducation.co.uk



Only £372.29
SAVE £160



alghamix II

ZHERMACK

- Alginate mechanical mixing machine.
- 30% saving on mixing time.
- Consistent, bubble-free alginate mix.

alghamix II Machine 230V, Bowl and Spatula
1105293 £372.29

Accessories Alginate Bowl

Blue 350cc
1105296 £17.49
Plaster Bowl for Dental Stone
Grey 600cc
1105299 £32.99

Was £12.99
Only £5.25

hydrogum®

ZHERMACK

- Alginate with silicone-like characteristics.
- 'Long Life System' for increased impression storage.

Refill
500g
1096925



From only £5.35

hydrogum® 5

ZHERMACK

- 'Long Life System' alginate with 5 day stability.
- Lilac colour with a fruity berry flavour.
- Setting time: 45 seconds in the mouth.
- 5 year shelf life.

Intro Kit
453g x 2, Measures and Container
1077780 £17.45
Refill
453g
1077781 £5.35



Was £10.59
Only £6.49

elite® ortho

ZHERMACK

- For all orthodontic work.
- Optimal compressive strength.
- Setting time: 10 mins.

White
3kg
1042362



From only £14.85

Orthoprint®

ZHERMACK

- Extra rapid setting alginate.
- Highly elastic.
- Vanilla flavour.
- Setting time: 45 seconds in the mouth.

Intro Kit
500g x 2, Measures and Container
011045 £14.85
Economy Pack
500g x 12
011046 £63.29



Impression Trays

ORTHO ORGANIZERS

- Feature deep vertical walls for accurate definition of occlusion and soft tissue.
- Perforated trays provide mechanical lock of impression material.
- Disposable or reusable.
- Cold sterilisation recommended.

Only £4.99

Upper x 10
1165044 Size 1 Red £4.99
1165045 Size 2 Orange £4.99
1165046 Size 3 Blue £4.99
1165047 Size 4 Green £4.99
1165048 Size 5 Yellow £4.99
1165049 Size 6 Purple £4.99
Lower x 10
1165050 Size 1 Red £4.99
1165051 Size 2 Orange £4.99
1165052 Size 3 Blue £4.99
1165053 Size 4 Green £4.99
1165054 Size 5 Yellow £4.99
1165055 Size 6 Purple £4.99

Was £14.49
Now only £9.99

Pegasus Orthodontic Trays

ASTEK

- High-quality, colour coded orthodontic impression trays.

Child Size 3 x 50

1115433 Upper Blue
1115434 Lower Blue

Adult Size 4 x 50

1115435 Upper Green
1115436 Lower Green

Adult Size 5 x 50

1115437 Upper Yellow
1115438 Lower Yellow

Adult Size 6 x 50

1115439 Upper Purple
1115440 Lower Purple





HENRY SCHEIN® BRAND
Orthodontic Debonding Burs

Pack of 5

| | | | |
|--|---------------------------------------|-----------------|---------|
| | Type: RA - ISO No.: 008 - Shape: 1172 | 8 Blade | 1125563 |
| | Type: FG - ISO No.: 008 - Shape: 1172 | 8 Blade | 1125568 |
| | Type: RA - ISO No.: 012 - Shape: 7006 | 12 Blade | 1125573 |
| | Type: FG - ISO No.: 012 - Shape: 7406 | 12 Blade | 1137409 |
| | Type: FG - ISO No.: 012 - Shape: 7803 | 12 Blade | 1137414 |
| | Type: FG - ISO No.: 012 - Shape: 7901 | 12 Blade | 1137408 |

Buy 2 get 1 FREE
From only £9.59
Mix & Match, lowest priced item sent free

| | | | |
|--|---------------------------------------|-----------------|---------|
| | Type: FG - ISO No.: 012 - Shape: 7902 | 12 Blade | 1137413 |
| | Type: FG - ISO No.: 012 - Shape: OF1 | 12 Blade | 1137410 |
| | Type: FG - ISO No.: 012 - Shape: 48L | 12 Blade | 1137411 |
| | Type: FG - ISO No.: 018 - Shape: 118S | 18 Blade | 1137406 |
| | Type: FG - ISO No.: 018 - Shape: 118L | 18 Blade | 1137407 |
| | Type: FG - ISO No.: 018 - Shape: 218 | 18 Blade | 1137412 |
| | Type: FG - ISO No.: 012 - Shape: 7642 | 12 Blade | 1137415 |

Was £56.99
Now only £39.99

Save 50% on Refill

Save 50% on Sealant Refill



Orthodontic Bracket Adhesive No Mix System

HENRY SCHEIN

- Bonding system for metal, plastic and ceramic brackets.
- Maximum strength in 5 minutes.
- No bracket flotation, hypoallergenic, no GMA.

Refills

| | | | |
|---------------------|--|---------|--------|
| Primer 13cc | 1084035 | £14.40 | |
| Tips x 27 | 1084036 | £29.99 | |
| Complete Kit | Preloaded Tips x 40, Primer 16cc and No Mix Components | 1084037 | £62.99 |

Save 50%



Orthodontic Bracket Adhesive Visible Light Cure System

HENRY SCHEIN

- Bonding system for use under metal, plastic, sapphire and ceramic brackets.
- Immediate archwire placement, easy removal.
- 3-year shelf life.

Complete Kit

| | | | |
|--|-----------|---------|--------|
| Preloaded Tips x 40, Sealant Resin 6cc, Etching Agent 9g, Brushes, Spatulas and Mixing Pad | 1084031 | £59.99 | |
| Refills | Tips x 40 | 1084033 | £44.99 |
| Sealant Resin 6cc | 1084034 | £7.65 | |

Save 50%

Orthodontic Bracket Adhesive Paste/Paste System

HENRY SCHEIN

- Direct and indirect bonding for molar attachments on metal or ceramic brackets.
- 30 seconds setting time to minimise bonding failures.
- 2-year shelf life, no refrigeration required.

Paste/Paste Kit

Catalyst 18g, Base 18g, Resin A 3g, Resin B 3g, Etching Agent 9g, Mixing Pad plus Accessories
1084032

VALO[®]

C O R D L E S S

Valo Cordless offers the same unprecedented accessibility and accuracy as the original Valo in a battery operated wand body.



Now Only
£1094.29

1128576

It is the perfect light for the practitioner who prefers the freedom of total mobility offered by cordless equipment.

Three curing modes - Standard, High and Xtra Power - offer unprecedented versatility for all curing needs.

Slim, wand-style body fits easily anywhere in the mouth, while 5 degree head angle provides direct access to the restoration site.

Cordless Kit includes

VALO Cordless LED Curing Light, Batteries (rechargeable) x 4, Battery Charger, Power Supply with Universal Plugs for Battery Charger, Handpiece Bracket Holder and Barrier Sleeves x 50.

 **ULTRADENT**
PRODUCTS, INC.

Taking care of everything dental. 0800 023 2558 henryschein.co.uk

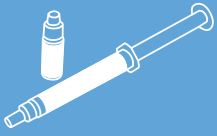

Was £151.29
Now only £98.90



Fuji ORTHO LC

GC

- Glass ionomer cement for orthodontic bonding of brackets and bands.
- Light-curing within 40 seconds.
- Easy removal of orthodontic appliances, no discolouration.
- Long-term fluoride release.

Refill

Capsules x 50
201925

Save 30%



Fuji ORTHO BAND LC PASTE PAK

GC

- Paste-to-paste light-curing, glass ionomer for bands and appliances.
- Cartridge delivery with controlled dosage.
- Light-curing 20 seconds, film thickness 3µm.
- High fluoride release.

Refill

PASTE PAK Cartridge 7.2ml x 2 and Mixing Pad No.22
1123306 £104.50

Save 30%



Fuji ORTHO Band Paste Pak

GC

- Paste-to-paste orthodontic cement in Paste Pak dispensing system.
- High fluoride release.
- Easy removal, blue colour.

Paste Pak

Cartridge 13.3g x 2 with Mixing Pad
800297 £102.05

Save 30%



Fuji ORTHO LC Self-Cured

GC

- Resin-reinforced, self-cure, glass ionomer, orthodontic luting cement.
- Easy removal of orthodontic appliances, no discolouration.
- Long-term fluoride release.

Intro Pack

Powder 15g, Liquid 6.8ml, Scoop and Pad
201712 £68.80

Refill

Powder 40g
201677 £84.90

Liquid 6.8ml
201678 £31.84

Accessories

Conditioner x 25g
201679 £19.10

Save 30%

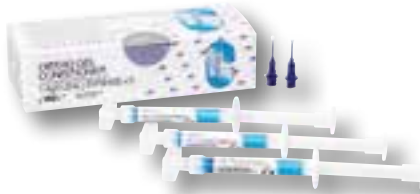

Fuji ORTHO GEL CONDITIONER

GC

- Polyacrylic acid gel solution (approx 20%) designed to mildly etch and condition enamel.
- Enhances bond strength of glass ionomer materials to tooth surface.

Syringe 1.2ml x 3 and Brush tips x 25

1123307 £45.35

Save 30%



Fuji ORTHO LC PASTE PAK Automix

GC

- Paste-to-paste light-curing, glass ionomer for orthodontic bonding.
- Light-curing 20 seconds, fluoride releasing.

Set

Cartridge 7.2ml, Ortho Gel Conditioner 1.2ml x 2, Mixing Tips x 20 and Brush Tips x 15

1123303 £153.50

Refill

PASTE PAK Cartridge 7.2ml x 2

1123304 £170.44

Trios[®] for Orthodontics

 HENRY SCHEIN[®]
DENTAL | ORTHODONTICS

Digital Solutions for Orthodontic Practices

- TRIOS Approved for Invisalign Case Submissions
- Flexible configuration options
- Reduce chair time
- Save storage space
- Create digital patients
- Share cases digitally

5 reasons to take impressions with TRIOS[®]

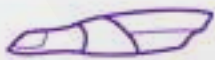

Superior scanning
technologies



RealColor™
intraoral photos



Flexible hardware
configurations

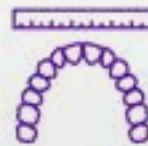

Analysis and treatment
planning software



Seamless case
sharing with labs

To find out how TRIOS[®] can save you time and money or for more information call **0800 023 2558**

Taking care of everything dental

henryschein.co.uk

Call **0800 023 2558** today or visit henryschein.co.uk

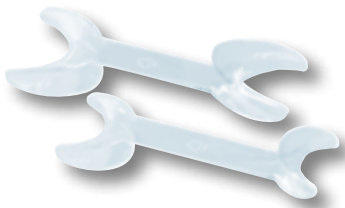
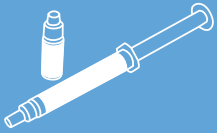

Double Ended Cheek Retractor

HENRY SCHEIN

- Provides complete retraction of the lips and cheek giving full view of the anterior and posterior teeth.
- Maximum retraction when you control the force.
- Disposable.

| | |
|------------------------|-------|
| Double Ended Large x 2 | |
| 1084823 | £3.99 |
| Double Ended Small x 2 | |
| 1084824 | £3.99 |



Stainless Steel Double Ended Cheek Retractor

HENRY SCHEIN

- Provides complete retraction of the lips and cheek giving full view of the anterior and posterior teeth.
- Maximum retraction when you control the force.
- Double ended.
- Glare-free brushed metal.
- Fully autoclavable.

| | |
|--------------|--------|
| Double Ended | |
| 1132153 | £20.79 |

RETRACTORS

BUY 3 GET 1 FREE

Mix & Match across this page
lowest priced item sent free

Extraoral Cheek Retractors

HENRY SCHEIN

- Provides complete retraction of lips and cheeks.
- Made from clear plastic - resistant to breaking.
- Disposable.

| | |
|---------------------|-------|
| Extraoral Adult x 2 | |
| 1084825 | £3.99 |
| Extraoral Child x 2 | |
| 1084826 | £3.99 |



Lip Retractors

ORTHO ORGANIZERS

- Transparent plastic lip retractors with long handles.
- Rounded edges.
- Excellent for photography.
- Can be cold sterilised.

| | |
|--------------|--------|
| Standard x 2 | |
| 1166071 | £15.29 |
| Mini x 2 | |
| 1166072 | £15.29 |



Combo Cheek Expander

ORTHO ORGANIZERS

- Expands the cheeks and simultaneously depresses the tongue for unrestricted access to the whole mouth.
- Can withstand temperatures of 370°F/188°C.
- Amber tint identifies it as an autoclavable plastic instrument.

| | |
|---------|--------|
| Small | |
| 1164351 | £17.49 |
| Medium | |
| 1164352 | £17.49 |
| Large | |
| 1164353 | £17.49 |



Tongue Shield

ORTHO ORGANIZERS

- Combination of two bite blocks and a vertical shield.
- Shield prevents tongue from touching the lingual surface of the anterior teeth.
- Centre hole allows for insertion of saliva ejector.
- Excellent during bonding procedures.
- Can be cold sterilised.

| | |
|-----------------|-------|
| Pink x 3 | |
| Adult/Teen | |
| 1166074 | £2.19 |
| Child/Paedo | |
| 1166075 | £2.19 |

Solutions for a better orthodontic practice

95%
OF CREDIT
APPLICATIONS
APPROVED*



Enjoy the benefits of finance

100% financing flexibility

You can generally finance 100% of your investment: (hardware, software, services, training), which can all be financed in one package". While most banks only lend over the short-term (typically 12-36 months), at Henry Schein Financial Services we offer financing terms ranging from 12 right up to 72 months.

Match costs with revenues

Rather than pay the full amount for equipment up-front, you only pay as you use it. At the end of the term you can choose to purchase your equipment, upgrade to new equipment or continue financing with substantial savings.

Strong credit lines

Because your credit lines remain intact, you have increased buying power and no tied up working capital. Finance also offers considerable fiscal advantages.

Easy forecasting

Fixed payments make your budgeting more transparent and cashflow forecasting easier. By locking in payments now, you can avoid inflation risk in the future.

Convenience

Leasing with Henry Schein Financial Services simplifies your administration: you can bundle all your equipment, technology, maintenance, insurance, services and other related acquisition costs into one contract. We even help you meet asset management and equipment lifecycle requirements.

Hire Purchase

Hire Purchase is by far the most popular form of dental equipment finance. It enables you to pay for dental equipment over a period of time and qualifies for the Annual Investment Allowance. Once all repayments have been made, you will own the dental equipment outright and be free to keep it for as long as required.

Our Hire Purchase agreements are competitive and extremely flexible and can be used to finance all types of equipment, including but not restricted to:

- Dental chairs and dental equipment
- Digital X-ray systems and dental CBCTs
- Autoclaves and washer disinfectors
- Dental CAD/CAM systems
- Dental cabinetry
- Computers, screens and audio visual equipment.

*Based on March 2016 data. 54% of applications approved without the need for additional financial information.

**Subject to policy

Henry Schein Financial Services: a partner for the long-term

At Henry Schein Financial Services we believe in partnerships. We work hard to see what counts for our customers and back up quality products with financial expertise and strong customer service. We do this so we can help you grow your business and reach your long-term goals.



Introducing the revolutionary Carriere[®] Motion Clear[™] Class II Appliance

- Sleek, aesthetic, and non-invasive design.
- Provides greater comfort and shortens treatment time.
- Delivers a natural, gentle, and uniform force for distal molar movement, with controlled rotation and tipping correction.
- Solves complex problems almost effortlessly.

See page 9 for more details.

STARTING
FROM
£50.39

The **New** Movement in **Orthodontics**

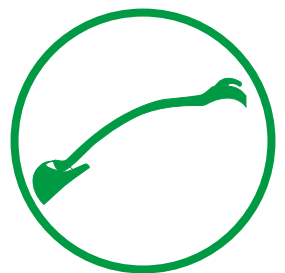
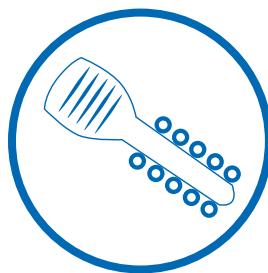
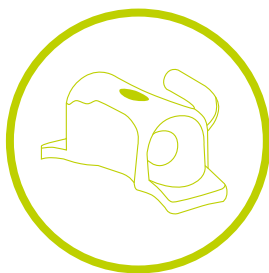
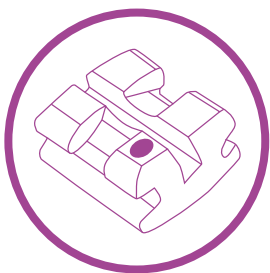

Terms and conditions apply. Offers valid until 31 March 2017 E & OE. All prices exclude VAT and are subject to availability or while stocks last. Henry Schein Dental reserve the right to correct clerical omissions and errors in this flyer. All pictures in this publication are for illustration purposes only. Henry Schein Dental standard terms and conditions apply. For full terms and conditions visit henryschein.co.uk